

# STANLEY®

# QuickSquare®

## Instruction Manual

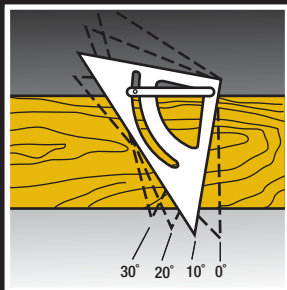
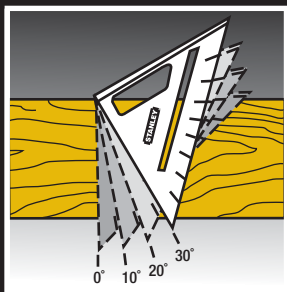

## INTRODUCTION

This booklet has been prepared for both the professional carpenter and the do-it-yourselfer! The information pertains to general roof construction and specifically to the Stanley **Quick Square® & Pocket Square®** tools.

The illustrations and instructions contained within this booklet are presented as recommended practice, but by no means do they imply that other techniques are not valid or acceptable.

Why not get yourself a cup of coffee, sit down, relax and read through this material to familiarize yourself with the features of the **Stanley Squares**, and refresh your memory of the various terms and definitions used in roof construction.

We start by illustrating the most common shapes of roofs, roof terminology, definitions, and types of rafters. Following is a description of the **Quick Square®** and **Pocket Square®**, and how they are used for rafter layout with illustrations and illustrated examples.

Then we describe and illustrate the additional features and uses designed into the **Stanley Squares**, such as the pro-tractor scale, the inch scale, and how to use the square as a saw guide.

At the rear of the booklet are tables of actual rafter lengths of common, hip and valley rafters for various building widths and roof rises, as well as a table for determining the differences in length of jack rafters for various on-center spacing.

***So sit back, relax, and let us show you how  
"Stanley helps you do things right"®***

## TYPE OF ROOFS

There are numerous types and shapes of roofs. The most common in use are the following:

### Shed or Lean-To-Roof

This is the simplest type of roof and has only a single slope



SHED OF  
LEAN-TO ROOF

### Gable or Pitch Roof

This is also a simple roof and the one most commonly used. It has two slopes meeting at the center or ridge and forming a gable.



GABLE ROOF

### Hip Roof

This roof consists of four sides, all sloping toward the center of the building. The corner rafters run up diagonally to meet the ridge.



HIP ROOF

### Gable and Valley or Hip and Valley

This is a combination of two gable or two hip roofs intersecting each other. The valley is the intersection of the two slopes at the roofs, which run in different directions. There are numerous modifications of this type of roof, and the most common is where the intersecting roofs are at right angles to each other.

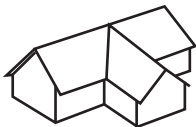

GABLE & VALLEY ROOF

### Deck Roof

This type of roof occurs when the rafters rise to meet a flat surface or "deck" instead of coming together at the ridge.

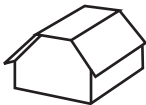

DECK ROOF

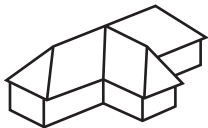

HIP & VALLEY ROOF

## **Definitions:**

There are many numbers of publications available concerning framing, roof construction and so on. For the most part these publications are fairly consistent in the terminology used in describing various structural members, etc. Unfortunately, when it comes to using certain terms relating to such things as rafter cuts, different words are used to mean the same thing-even within the same publication (i.e. bottom cut, seat cut, heel cut, fascia cut, etc.). Therefore, in the interest of consistency and clarity, we shall use one term in these instances.

The following definitions relating to the various roof members and terms used in roof construction-and throughout this booklet-should be carefully noted and committed to memory.

### **Rafter**

The sloping structural members which support the roof .There are four distinct types of rafters, Common, Hip, Valley and Jack. (Ref. Booklet Cover).

### **Common Rafter**

A rafter extending from the plate to the ridge or ridge board and perpendicular to the plate and ridge in a plan view.

### **Hip Rafter**

A rafter extending diagonally from the outside corner of intersecting plates to the ridge board, usually at an angle of  $45^{\circ}$  to the plate in a plan view,

### **Valley Rafter**

A rafter extending diagonally from the inside corner of intersecting plates to the ridge of one of the intersecting roots. In most cases at an angle of  $45^{\circ}$  to the plate(s) in plan view.

### **Jack Rafter**

A rafter that does not extend from plate to ridge. They lie in the same plane as common rafters and either abuts plate and hip, ridge and valley or hip and valley rafters, and is classified as follows:

### **Hip Jack**

A rafter extending from plate to hip rafter at right angles to the plate in plan view.

### **Valley Jack**

A rafter extending from ridge to valley rafter at right angles to the ridge in plan view.

### **Cripple Jack**

A rafter extending between a hip rafter and a valley rafter at right angles to the ridge and plate in plan view. A cripple jack abuts neither a ridge or plate.

## Definitions: (Continued)

### Cuts

Naturally all rafters must be cut to specific dimensions in order to properly fit in the space they are to occupy. The mating surfaces of the rafter and abutted roof members must fit flush, and as witnessed by the variety of roof styles and different kinds of rafters. A variety of cuts will be required to insure a proper rafter fit. There are basically four cuts made on rafters – plumb, seat, heel and side cut.

#### Plumb Cut

The cut at the top or bottom of any rafter, which is perpendicular to the span (width) of the building when the rafter is in position. (Also called the top plumb or bottom plumb cut.)

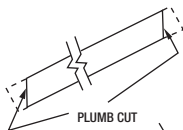

#### Seat or Level Cut

The cut made at the bottom of any rafter resting on the horizontal surface of the plate.

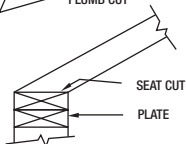

#### Heel Cut

The cut made at the bottom end of any rafter, which bears against the vertical surface of the plate. Note that this is parallel to the plumb cut.

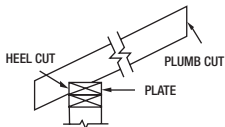

#### Side Cut

The cut made at the end of a rafter that abuts the ridge or other rafter at other than 90° in plan view. This cut is required at the top end of all hip, valley, and hip jack and cripple jack rafters and at the bottom end of valley jack and cripple jack rafters. (Also called cheek or bevel cut.)

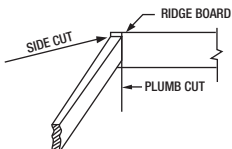

## Definitions: (Continued)

### Cuts (Continued)

#### Birds Mouth

The notch formed, at the bottom end of rafters, as a result of a seal cut and heel cut is called a birds mouth. The depth of birds mouth is made to the location of measuring line. (Refer to definition of "measuring hoe")

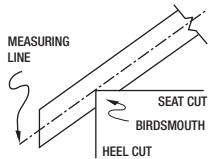

#### Ridge Board

The ridge board is the horizontal member at the peak of the roof to which the upper ends of the rafters on both sides of the roof are fastened.

In less expensive construction, sometimes the ridge boards are omitted and opposite rafters are fastened to each other forming the ridge.

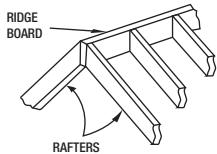

#### Plate

The plate is the roof member to which the lower ends of the rafters are fastened. The plates are located on the tops of the outside walls.

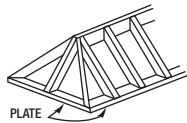

#### Span

The span of a roof is the distance from outside of the building wall to the outside of the opposite wall, or basically the outside width of the building.

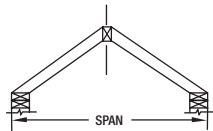

#### Run

The run of a roof is the horizontal distance from the center of the ridge to the outside of the wall (or plate). In equally pitched roofs and where the plates are on the same plane, the run is equal to half the span, therefore, half the building width. In shed or lean-to type roofs, the run is equal to the span, less the thickness of the wall.

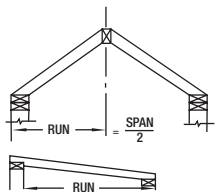

## Definitions: (Continued)

### Rise

The rise of a roof is the vertical distance from the top of the plate to the intersection of the measuring lines of opposing common rafters. (See "Measuring Line" for the location of this line on common rafters.)

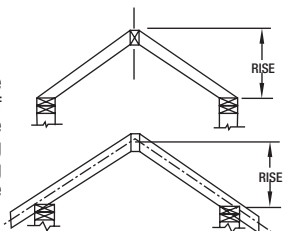

### Unit Rise

The unit rise of a roof is the vertical distance a roof raises for each 1 foot of roof run (unit run).

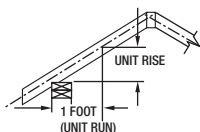

### Pitch

The pitch of a roof is the ratio of rise in feet to span in feet or unit rise to unit span. To find the pitch, divide the rise by the span

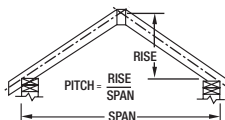

### Slope

The slant of a roof is more commonly being expressed in terms of "slope" as opposed to "pitch." Building plans usually include the roof slope defined by a small triangle, called the slope Triangle. The slope of a roof is the ratio of the rise in inches to a run of 12 inches.

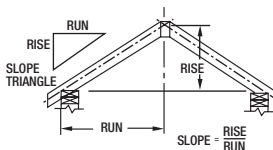

## Definitions: (Continued)

### Eave

Most buildings are constructed with an overhang, that is, the roof ends beyond the outside wall of the building. The extension at the rafter necessary to provide this overhang is called an eave (sometimes referred to as tail). The length of an eave is calculated independently of the rafter length, but the two are added together to obtain the total rafter length.

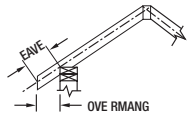

### Plan View

The plan view is a view looking straight down on the roof

### Measuring Line

The length of a rafter is measured and laid out on a measuring line on the rafter. The measuring line on a common rafter with an eave, is located along the side of rafter parallel to the top edge. Rafters made by 2 x 4's, lay a carpenter square body flush with top edge of the rafter and marking the bottom edge of the square body. For rafters made in 2 x 6's or larger, lay the square body flush with the bottom edge of the rafter and mark along top edge of the square body.

On rafters without an eave, the measuring line is along the top edge of the rafter.

The measuring line on hip, valley, and jack rafters is located along the centerline on top of the rafter.

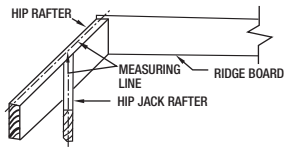
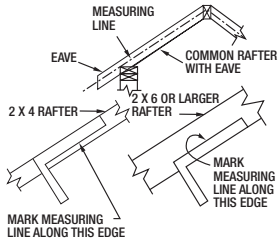



# THE STANLEY QUICK SQUARE® TOOL

The Stanley **Quick Square**® is designed to provide a quick, accurate, and repeatable means for laying out and cutting the various cuts on common, hip, valley and jack rafters used in roof construction.

## Description

The Stanley **Quick Square**® is constructed basically of three (3) parts, namely Refer to Figure 1):

- 1) The Body
- 2) The Adjustable Arm
- 3) The Locking Screw

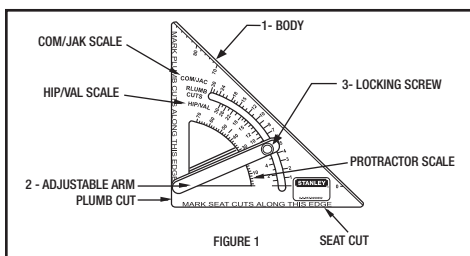

## 1) The Body

The body is manufactured from a non-corrosive aluminum die casting. Scales graduated in terms of inch rise per foot of run or the various rafters are cast into both sides of the body to extremely accurate tolerances. For additional convenience, protractor scales graduated in degrees, as well as an inch scale graduated every 1/8-inch are also cast into the body.

## 2) The Adjustable Arm

The adjustable arm is also manufactured from a non-corrosive aluminum die casting. The arm is positioned with its top edge aligned with the desired inch rise per foot run marking on the body to obtain the correct angle for marking and cutting the rafter.

## 3) The Locking Screw

The locking screw, also of aluminum, is used to lock the adjustable arm at the desired rise marking on the body.

# THE STANLEY QUICK SQUARE® TOOL

## Plumb Cuts

Loosen the locking screw and set the adjustable arm so that its top edge coincides with the desired inch rise per foot of run (slope) for the desired type of rafter. Tighten the locking screw to lock the arms in position (Refer to Figure 2A)

At one end at the rafter lay the **Quick Square®** on the side of the rafter with the top at the adjustable arm placed against the bottom edge at the rafter. (Refer to Figure 2B)

Along the edge marked for plumb cuts, mark the rafter as shown in figure 2C.

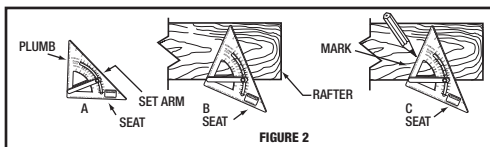

## Rafter Length

To find the length of a rafter (common, hip, or valley) for a specific roof pitch and building width. First look up the required building width in Table 1. Next, find the desired rise in inches per foot of run (slope) in the left hand column, and read the exact rafter length required to the right of the rise under the column for the type of rafter desired.

Along the measuring line, lay out and mark the length of the rafter.

The lengths of rafters obtained from the tables are to the center at the ridge. Therefore, half of the thickness at the ridge board should always be deducted from the listed rafter length before the top plumb cut is made. (See Figure 3)

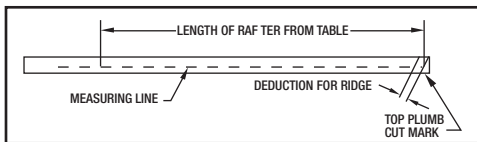

## Using the Stanley Quick Square® Tool

The deduction of half the thickness of the ridge board is measured at right angles to the top plumb cut line and is marked parallel to the top plumb cut line.

A right angle line to the top plumb cut line is easily made with the Stanley **Quick Square**®.

Without changing the position of the adjustable arm originally set, rotate the **Quick Square**® so that the bottom of the adjustable arm now rests against the bottom edge of the rafter. Slide the square so that right edge marked for seat cuts overlaps the top plumb cut mark, and mark the rafter along that edge. (See Figure 4)

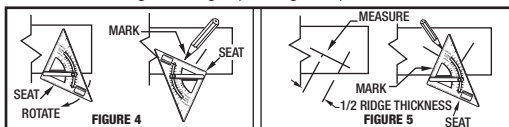

Now along this line, measure and mark half the thickness of the ridge board from the top plumb cut line. Next, rotate the square to its original position and place the square so that the edge marked for plumb cuts is set on the mark just made. Be sure the top of the adjustable arm is snug against the bottom edge of the rafter. Now mark the rafter along the edge of the square marked for plumb cuts. (See Figure 5)

(Note: For jack rafter lengths, refer to pages 21 through 25).

### Seat Cuts

The seat cut is made perpendicular to the bottom plumb heel cut where it intersects the measuring line at a distance from the original top plumb cut line, equal to the rafter length.

To obtain the seat cut, again rotate the square so that the bottom edge of the adjustable arm is against the bottom edge of the rafter. Now position the square so that the edge marked for seat cuts coincides with the bottom plumb cut line (heel cut) at the measuring line. Mark the seat cut from the bottom plumb cut line to the bottom edge of the rafter. (See Figure 6A & 6B)

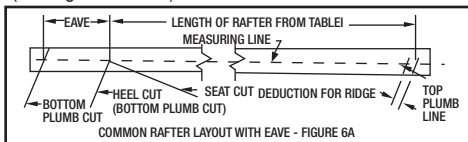

## Using the Stanley Quick Square® Tool

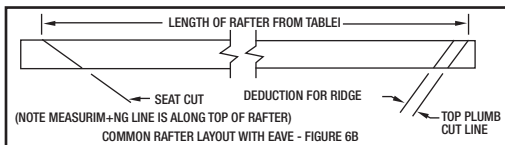

The preceding paragraphs in this section described how to use the **Quick Square®** for making plumb, seat, and heel cuts, determining the length of a rafter, and were general in nature.

Let's now take a look at an example for laying out and cutting common, hip, valley and jack rafters for a specific building width and roof rise. The roof is also to have an overhang.

### Building Specification

- Width ..... 20 feet
- Rise ..... 9 inches per foot run
- Ridge ..... 2x8 (1 1/2 in. actual ridge thickness)
- Eave Length ..... 2 feet
- Rafter Spacing .... 16 inch centers
- Rafter Stock ..... 2 x 6
- Plate Stock ..... 2 x 6

### Common Rafter

1) Set the top edge of the arm of the **Quick Square®** at the '9' graduation (between the 8 and 10) on the scale for com/jack.

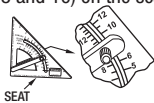

2) Mark the top plumb cut line at one end of the rafter

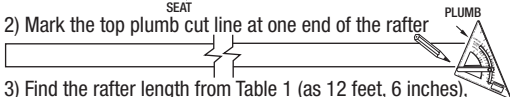

3) Find the rafter length from Table 1 (as 12 feet, 6 inches), and lay out and mark this length on the measuring line.

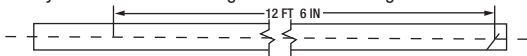

4) Subtract 1/2 of the thickness of the ridge board (in this case 3/4 inch) from the top plumb cut line.

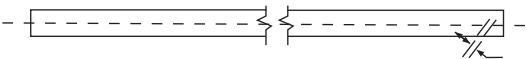

## Using the Stanley Quick Square® Tool

5) Mark the heel cut (a bottom plumb cut line) and the seat cut lines.

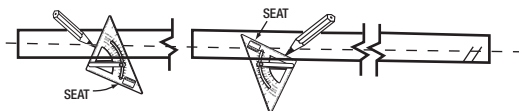

6) Add 2 feet. For the length of the eave, from the heel cut line along the measuring line and mark a bottom plumb cut line.

7) Once the rafter has been cut, it may now be used as template for laying out the rest of the common rafters.

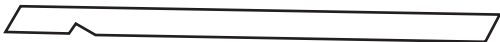

### Hip and Valley Rafter

1) Set the top edge of the arm of the **Quick Square**® at the '9' graduation (between the 8 and 10) on the scale for hip/val.

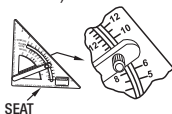

2) Mark the top plumb cut at one end of the rafter.

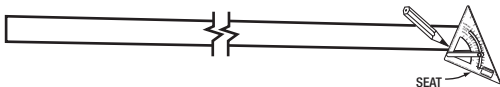

## Using the Stanley Quick Square® Tool

3) Rotate the **Quick Square**® and mark a line perpendicular to the plumb cut line. Along this line, measure and mark the thickness of the rafter.

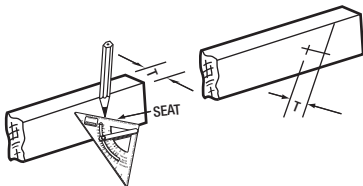

4) Make a second plumb cut mark at this point.

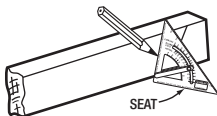

5) Set the arm on the Quick Square at 0 degrees and extend both plumb cut marks square across the top of the rafter.

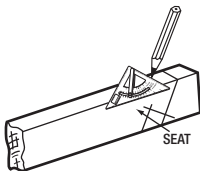

## Using the Stanley Quick Square® Tool

6) Connect opposite ends of the square fines, which will give the correct side cut angle. Note that rafters with opposite side cut angles will be required for opposing hip rafters and valley rafters.

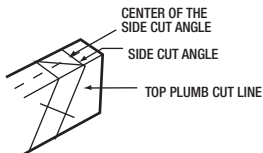

7) From the center of the side cut angle, lay out and mark the rafter length on the measuring line, as obtained from Table 1. (You will remember that we defined the measuring line on hip, valley and jack rafters as along the center line on top of the rafter.)

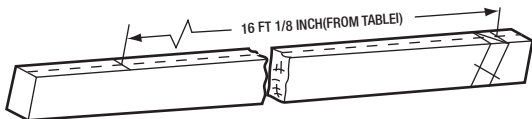

8) Square the length of the rafter across the top of the rafter, arm mark a bottom plumb cut line on the side of the rafter.

If you are laying out a valley rafter, add a second plumb line  $\frac{1}{2}$  the thickness of the rafter from the plumb line just made! This is the line along which the heel cut will be made on the valley rafter to fit the intersecting plates.

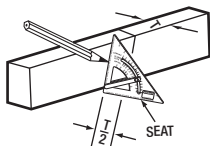
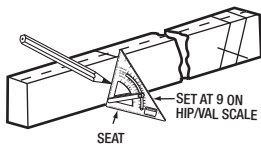

## Using the Stanley Quick Square® Tool

9) Measure the depth of the heel cut from a common rafter, and mark the seat cut line (using the '9' setting on the hip/val scale).

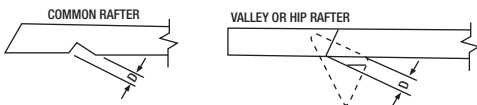

10) Now the deduction for the ridge board thickness must be subtracted from the rafter length obtained from Table 1. Since the hip and valley rafters sit at an angle of 45 degrees to the ridge in the plan view, the thickness of the ridge board must be measured on a 45 degree diagonal line.

Set and lock the arm on the square at 45 degrees. Draw a 45 degree fine across the top at the ridge board. Measure the length of the line and divide by 2. (In this case, the line should be  $2\frac{1}{8}$  inches long divided by 2 =  $1\frac{1}{16}$  inch)

11) Along the perpendicular line laid out in Step 3), and trim the original top plumb cut line, measure and mark  $1\frac{1}{16}$  inch, and at this mark make another top plumb cut line.

12) From the top of this top plumb cut line, draw another side cut line parallel to the side cut line made in Step 6). These last top plumb and side cut lines define the angle at which the end of the rafter is to be cut to fit flush against the ridge board.

Note that a portable electric circular saw is used to cut this end of the rafter, that by tilting the blade at an angle of 45 degrees to the sole plate of the now, and cutting along the top plumb cut line. The result will be the correct side cut angle! It is best to lay out the side cut angle on top at the rafter in any case, in order to be sure the tilt of the blade angle is in the right direction to result in the desired side cut!

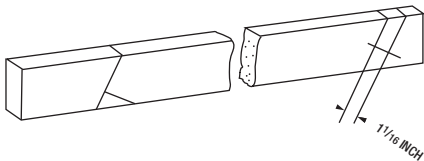



## Using the Stanley Quick Square® Tool

13) We must now consider the additional length that must be added to the length of the rafter to accommodate the eave. We calculate this by ratios. First, determine the length of common and hip/valley rafters for this pitch roof. In our example, the rafter length is 12'6". The length of the hip rafter is 16<sup>1</sup>/<sub>8</sub>". The ratio of hip rafter length to common rafter length is:

$$\frac{16\frac{1}{8}}{12' 6"} = \frac{(16 \times 12) + .125}{(12 \times 12) + 6} = \frac{192.125}{150} = 1.28$$

This ratio holds or the eave length at the tip or valley rafter divided by the eave length at the common rafter.

$$\frac{D}{C} = 1.28 \text{ where } D \text{ is the length of}$$

the hip or valley eave, and C is the length of the common rafter eave, as shown in the diagram below in our example:

$$\frac{D}{24"} = 1.28, \text{ then } D = 24" \times 1.28 = 30.72"$$

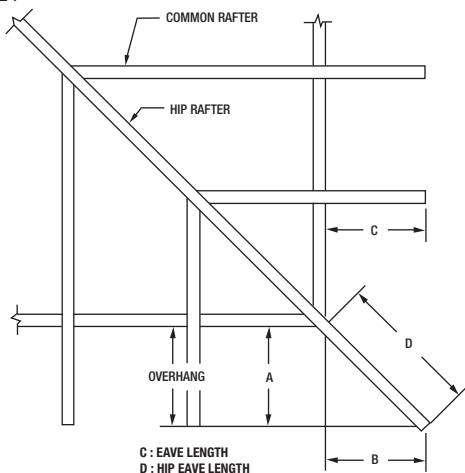

## Using the Stanley Quick Square® Tool

14) From the squared line across the top of the rafter at the bottom plumb cut line, measure and mark  $30\frac{3}{4}$  inches (eave length). Square this line across the top of the rafter, and mark another bottom plumb cut line on the side of the rafter from this squared line.

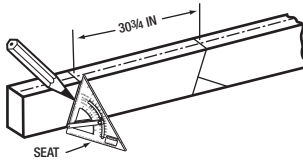

15) Since the length of the hip rafter and valley rafter are measured along the center line on top of the rafter, you can see that the corners at the bottom end of the eave are not in the same plane as the ends of the common rafters.

The cut-off length or the allowance for the mitre is half the thickness of the hip rafter as illustrated below in plan view.

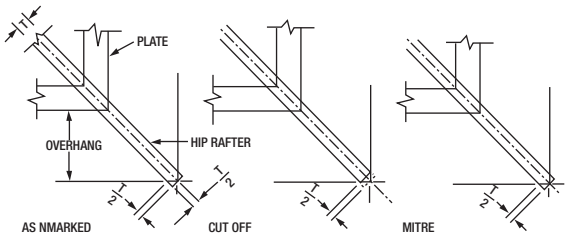

## Using the Stanley Quick Square® Tool

Some carpenters and roof framers prefer to mark and cut the eave after the hip rafter is in place by snapping a chalk line from the ends of the common rafters.

The cut-off is made along a plumb line laid out from the chalk mark, or as laid out to the calculated length above, with the blade of a portable electric saw set at an angle of 90 degrees to the soleplate.

The mitre cut is made along a plumb line with the blade of a portable electric saw set at an angle of 45 degrees to the soleplate.

16) In the case of the valley rafter, it is not necessary to foreshorten or mitre the end of the rafter since the measured length of the eave (measured along the top of the rafter) lies in the same plane as the ends of the common rafters, as show in plan view below!

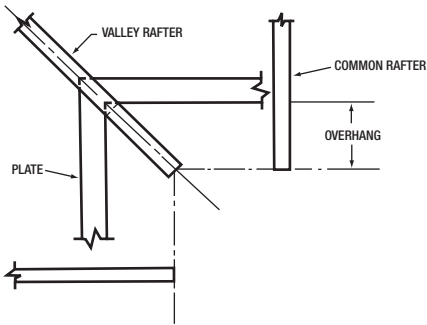

For those who want to make the effort, a 90 degree notch can be made at the bottom of the rafter to provide a better surface for fastening the fascia board. In this case, half the thickness of the valley rafter must be added to the length of the rafter, as illustrated below. A plumb line would again be drawn on the side of the rafter at this point, and with the blade set at 45 degrees on a portable electric saw, and at the proper depth, a cut is made along the plumb line on both sides of the rafter.

## Using the Stanley Quick Square® Tool

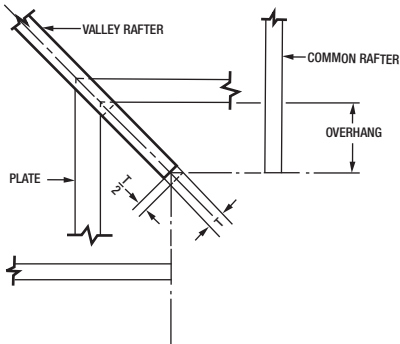

17) When budding a hip roof the ridge board should be left about a foot longer than necessary at the ends. Then a common rafter, which has been cut to size, is placed on the center of the end plate, and the upper end positioned alongside the ridge board, aligning the top end at the common rafter with the top of the ridge board.

The ridge board is then marked at the end at the common rafter.

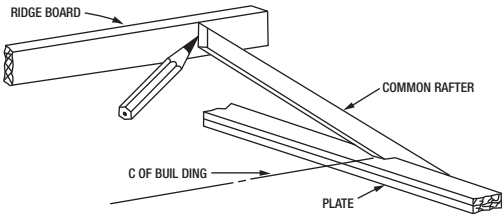

If a center common ridge rafter is used, the ridge board is cut to length at this mark, and the hip rafters are fastened at the top end of the common ridge rafter.

If no center common ridge rafter is used, add 2 inches to the length of the ridge board from the mark just made, to provide a surface to fasten the upper end of the hip rafter, and cut off the ridge board at this point.

# Using the Stanley Quick Square® Tool

## Jack Rafter

Jack rafters lie in the same plane as common rafters, and therefore have the same inch rise per foot run as common rafters.

1) Set the adjustable arm to the required graduation on the 'Com/Jack' scale-in this case, '9', as was done for the common rafter layout.

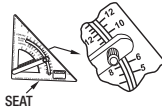

2) At one end of the rafter, mark a plumb cut line.

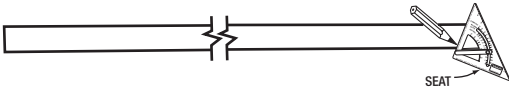

3) Rotate the square and mark a line perpendicular to the plumb cut line. Along this line measure and mark the thickness of the rafter.

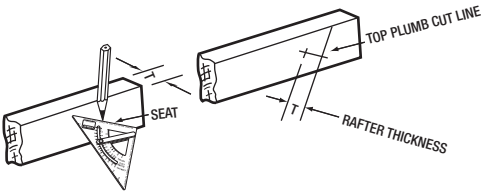

4) Mark a second plumb cut line at this point.

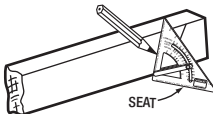

## Using the Stanley Quick Square® Tool

5) Square the top at the plumb lines across the top of the rafter. Note that in the case of a valley-jack rafter, the top of the rafter is on the 'short' side at the plumb line—that is, just the opposite side of a hip-jack!

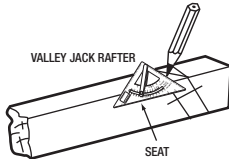
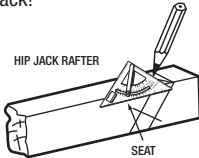

6) Depending on which way the side cut is to be made, connect opposite ends of the square fines.

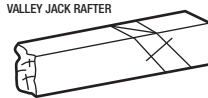
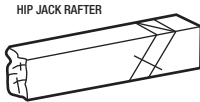

7) From Table 2, "Difference in Length at Jack Rafters for Various Spacing," the length given for 9 inch rise per foot run on 16 inch centers is 1 foot, 8 inches. This is also the length of the first, or shortest hip-jack or valley-jack rafter. Each succeeding jack rafter will be 1 foot, 8 inches longer than the preceding one!

8) Along the measuring line (the center line on top of the rafter), and from the side cut line marked in Step 6), measure and mark the length of the rafter. The first rafter will be 1 foot, 8 inches long, the second rafter 3 feet, 4 inches long (2 times 1 foot, 8 inches), the third rafter 5 feet, 0 inches (3 times 1 foot, 8 inches), and so on!

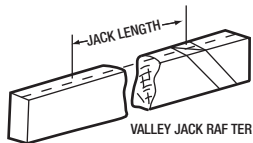
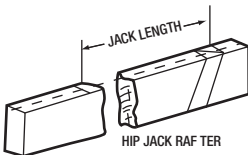

## Using the Stanley Quick Square® Tool

9) From the length marked, mark a plumb cut line on the side of the rafter.

10) For a valley-jack, the rafter will be cut parallel to this line to fit against the ridge board. Be sure this plumb line on the valley-jack is in the same direction as the plumb line at the opposite end of the rafter, that is, parallel to it!

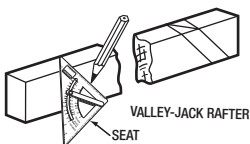

11) For a hip-jack, use a common rafter as template, and mark the heel and seat cuts (birdsmouth), on the side of the rafter at the bottom plumb cut line. In case there isn't a common rafter available, lay out the heel and seat cut lines as described on page 11 under Seat Cuts.

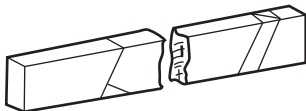

12) Again on a hip-jack, the additional length for the eave is laid out the same as it was for the common rafter. A common rafter may be used as template, if one is available!

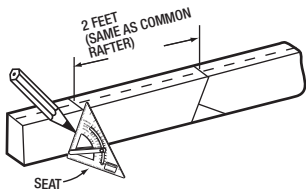

## Using the Stanley Quick Square® Tool

13) Compensation must now be made for the thickness of the hip or valley rafter in the length of the jack rafter, as was done for the hip and valley rafter to compensate for the thickness of the ridge board. With the **Quick Square®** set on the '9' of the 'Com/Jack' scale, mark another plumb cut line on the side of the rafter  $1 \frac{1}{16}$  inch from the original plumb cut mark made in Step 2 above. (The  $\frac{11}{16}$  inch dimension being half the diagonal thickness of the hip or valley rafter).

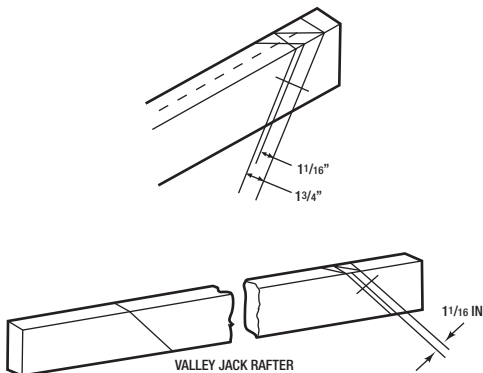

14) From the top of this plumb line, mark a line across the top of the rafter parallel to the side cut mark made in Step No. 6). These last side and plumb cut marks are the marks on which the rafter will be cut. Cutting along this plumb cut line with a portable electric circular saw set a 45 degrees, will result in the correct side cut angle!



## Using the Stanley Quick Square® Tool

15) A valley-jack rafter must be further reduced in length to compensate for the thickness of the ridge board which it abuts. This is accomplished in the same manner in which the common rafter was shortened, and for the same reason. (Refer to Page 10-Rafter Length)

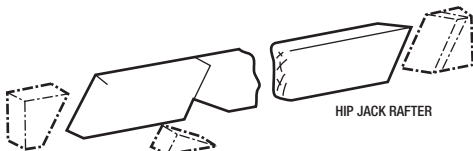
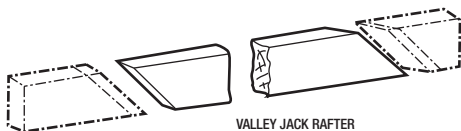
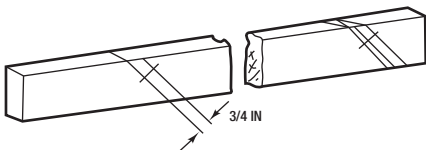

## ADDITIONAL FEATURES AND USES

### Protractor Scale

The **Quick Square®** is embossed with a scale, graduated in degrees which makes it very handy for use as an adjustable protractor! The scale is embossed on both sides of the square body so that either side may be used. The illustration below shows the angles which may be obtained with the adjustable arm set at the 30 degree graduation.

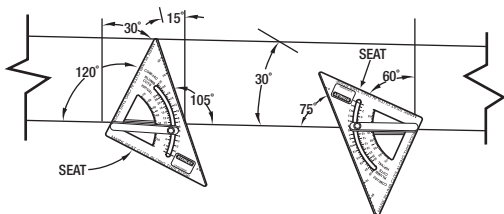

Used in conjunction with a level, the **Quick Square®** may be used to determine angles of construction members, the rise of existing roofs and rafters, or to adjust a member to any desired angle, as illustrated below.

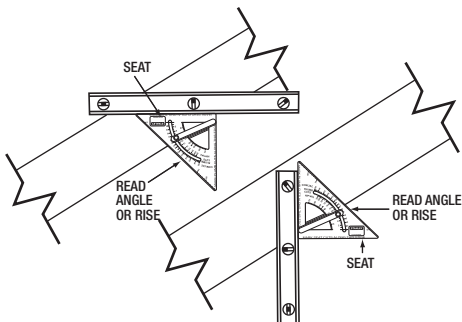

## THE INCH SCALE

On one side of the **Quick Square**® tool is an embossed scale, graduated every 1/8 of an inch.

By setting the adjustable arm to zero (0) degrees the **Quick Square**® may be used as an ordinary square for measuring, and /or marking a dimension square to the edge of a board. The scale may only be used in conjunction with the adjustable arm when the arm is set to (0). Any other arm setting will not align the arm with the zero on the scale. However, since the scale is an accurate one, it may be used as a conventional scale for measuring and marking by aligning the zero (0) with the edge of the work piece by eye.

The Stanley **Pocket Square**® is embossed with a scale, 63/4 inches long, and graduated every 1/8 of an inch on both sides. It may be used as a conventional scale for measuring and marking by aligning the pivot point up with the edge of the work by eye.

## AS A SAW GUIDE

The **Stanley Square**, aside from being a tool for quickly and accurately laying out rafters, may be used as a saw guide for a portable electric circular saw or an electric saber saw.

Once set at the desired angle, the square may be used on either edge of a rafter, not only for marking the rafter, but also as a guide for cuffing the rafter at the correct angle. Make sure the square is clamped tightly against the work piece, and that the saw is guided along the edge of the square.

# THE STANLEY POCKET SQUARE

The Stanley **Pocket Square**® is designed to provide a quick, accurate, and repeatable means for laying out and cutting the various cuts on common, hip, valley and jack rafters used in roof construction.

## Description

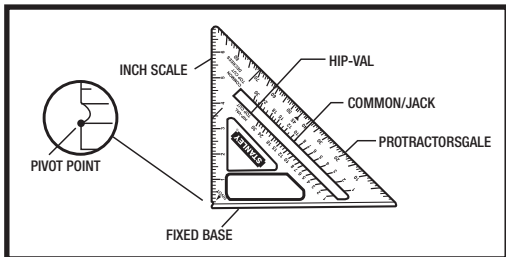

## Features

- 1) Common/Jack and Hip/Valley rafter scales-Defined by inch rise per foot of run.
- 2) Protractor Scale-Graduated in degrees.
- 3) Inch Scale-63/4" long graduated every 1/8 inch.
- 4) Fixed base.
- 5) For use as a saw guide.

## Using the Stanley Pocket Square

Place the square on the face of the rafter, near the top end of the rafter. Pivot the square so that the number 6 (6" rise) on the common scale lines up with the rafter. While holding the pivot firmly against the rafter and keeping the number 6 lined up properly, mark your line, starting at the pivot point along the top edge of the square. This will be the top plumb cut line. (See Figure 2)

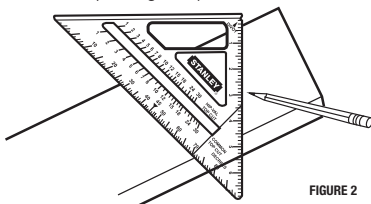

FIGURE 2

Illustration shows the square in position for marking the top plumb cut of a common rafter having a 6" rise, also showing a  $26\frac{1}{2}$  degree angle.

## Rafter Length

To find the length of a rafter (common, hip or valley) for a specific roof pitch and building width. First look up the required building width in Table 1. Next, find the desired rise in inches per foot of run (slope), in the left hand column, and read the exact rafter length length required to the right of the rise, under the column for the type of rafter desired.

Along the measuring line (refer to page 8), lay out and mark the length on the rafter.

Note: The length of rafters obtained from tables are to the center of the ridge. Therefore, half of the thickness of the ridge board should always be deducted from the listed rafter length before the top plumb cut is made. (See Figure 3)

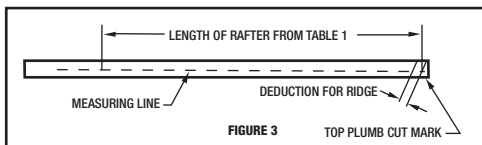

FIGURE 3

TOP PLUMB CUT MARK

## Using the Stanley Pocket Square (continued)

The deduction of half the thickness of the ridge board is measured at right angles to the top plumb cut line and is marked parallel to the top plumb cut line.

A right angle line to the top plumb cut line is easily made with the Stanley **Pocket Square®**.

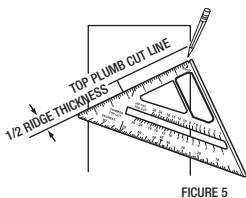
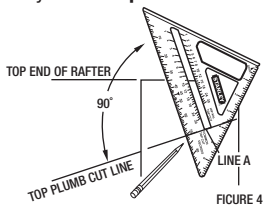

Simply line up A on the square so that it coincides with the top plumb cut line you just made. Your protractor scale edge will now be 90 degrees to your plumb cut line. Mark a line, along your protractor scale edge, on which you will measure and mark 1/2 your ridge thickness. (See Figure 4)

After marking 1/2 the ridge thickness, mark another line, through this mark, parallel to the original top plumb cut line. (See Figure 5)

NOTE: For jack rafter lengths, refer to pages 40 thru 44.

### Seat Cuts

The seat cut is made perpendicular to the bottom plumb cut (heel cut) where it intersects the measuring line at a distance from the original top plumb cut line, equal to the rafter length.

To obtain the seat cut, construct another plumb cut line so that it crosses the measure line at the point that defines the rafter length. Line up line A on the square with the bottom plumb cut line made and move the square along this line until the edge of the square reaches the rafter length point on the measure line. Now mark a line from this point to the bottom of the square. This is your seat cut line. (See Figure 6A & 6B)

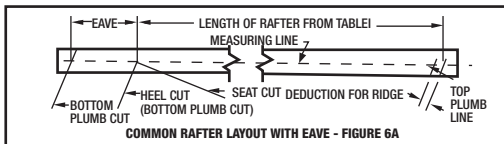

COMMON RAFTER LAYOUT WITH EAVE - FIGURE 6A

## Using the Stanley Pocket Square (continued)

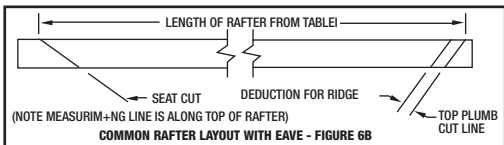

The preceding paragraphs in this section describe how to use the **Pocket Square®** for making plumb, seat and heel cuts, determining the length of a rafter, and were general in nature.

Let's now take a look at an example for laying out and cutting common hip, valley and jack rafters for a specific building width and roof rise, the roof is also to have an overhang.

### Building Specification

Width.....	20 feet
Rise.....	9 inches per foot run
Ridge.....	2 x 8 (1½ in. actual ridge thickness)
Eave Length.....	2 feet
Rafter Spacing.....	16 inch centers
Rafter Stock.....	2 x 6
Plate Stock.....	2 x 6

### Common Rafter

1) Set the pivot of the Stanley **Pocket Square®** on the rafter edge. Rotate the square about the pivot point until the edge of the rafter lines up at '9' (between 8 and 10) on the scale for COM/JACK.



2) Mark the top plumb cut line at one end of the rafter.

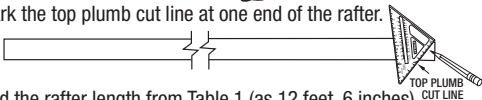

3) Find the rafter length from Table 1 (as 12 feet, 6 inches), and lay out and mark this length on the measuring line.

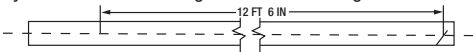

4) Subtract 1/2 of the thickness of the ridge board (in this case 3/4 inch) from the top plumb cut line.

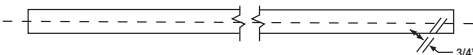

## Using the Stanley Pocket Square (continued)

- 5) Mark a heel cut (bottom plumb cut line) and the seat cut lines.

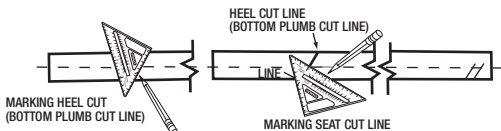

- 6) Add 2 feet, for the length of the eave, from the heel cut line along the measuring line and mark a bottom plumb cut line.

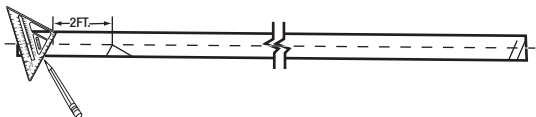

- 7) Once the rafter has been cut, it may now be used as a template for laying out the rest of the common rafters.

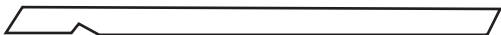

## Hip and Valley Rafter

- 1) Set the pivot at the Stanley **Pocket Square**® on the rafter edge. Rotate the square about the pivot point until the edge of the rafter lines up at '9' (between 8 and 10) on the scale for HIP/VAL.

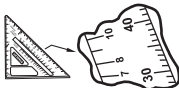

- 2) Mark the top plumb cut line at one end at the rafter.

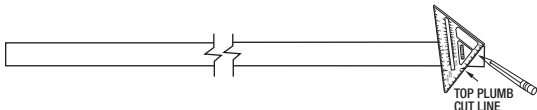



## Using the Stanley Pocket Square (continued)

3) Rotate the **Pocket Square**® and mark a line perpendicular to the top plumb cut line. Along this line measure and mark the thickness of the rafter.

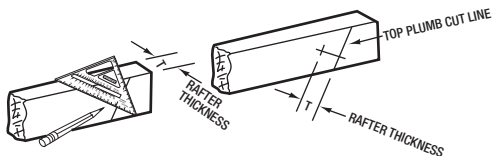

4) Make a second plumb cut mark at this point.

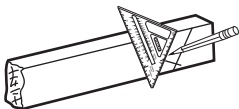

5) Set the Stanley **Pocket Square**® on the top edge of the rafter. Extend both plumb cut marks square across the top of the rafter.

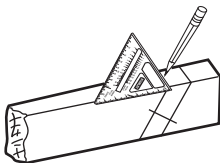

## Using the Stanley Pocket Square (continued)

6) Connect opposite ends of the square lines, which will give the correct side cut angle. Note that rafters with opposite side cut angles will be required for opposing hip rafters and valley rafters.

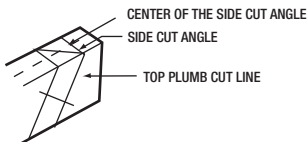

7) From the center of the side cut angle, lay out and mark the rafter length on the measuring line, as obtained from Table 1, (You will remember that we defined the measuring line on hip, valley and jack rafters as along the center line on top of the rafter.)

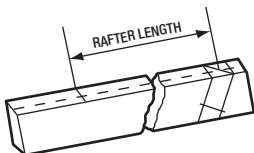

8) After marking the rafter length, mark a square line as shown above, Now mark a bottom plumb cut line on the side of the rafter as shown below left.

NOTE: If you are laying out a valley rafter, add a second plumb line 1/2 the thickness of the rafter from the plumb line just made, as shown below right. This is the line along which the heel cut will be made on the valley rafter to fit the intersecting plates.

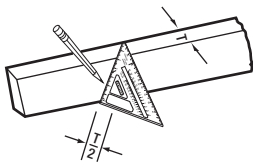
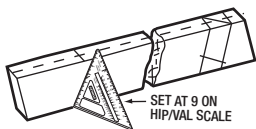

## Using the Stanley Pocket Square (continued)

9) Measure the depth (D) at the heel cut from a common rafter, and mark the seat cut line by setting the pivot at the square on the edge of the rafter. Rotate the square about the pivot until the edge of the rafter lines up at the '9' on the HIP/VAL scale.

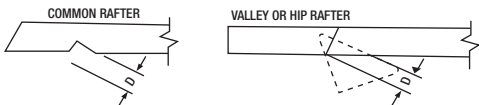

10) Now we move back to the top plumb cut line. The deduction for the ridge board thickness must be subtracted from the rafter length previously obtained from Table 1. Since the hip and valley rafters sit at an angle at 45 degrees to the ridge in the plan view, the thickness of the ridge board must be measured on a 45 degree diagonal line. Draw a 45 degree line across the top of the ridge board. Measure the length of the line and divide by 2. (In this case, the line should be  $2\frac{1}{8}$  inches long-divided by 2 =  $1\frac{1}{16}$  inch.)

11) Along the perpendicular line laid out in Step 3, page 33, and from the original top plumb cut line, measure and mark  $1\frac{1}{16}$  inch. and at this mark make another top plumb cut line.

12) From the top at this top plumb cut line, draw another side cut line parallel to the side cut line made in Step 6). These last top plumb and side cut lines define the angle at which the end of the rafter is to be cut to fit flush against the ridge board.

Note that if a portable electric circular saw is used to cut this end of the rafter, that by tilting the blade at an angle of 45 degrees to the sole plate of the saw, and cutting along the top plumb cut line, the result will be the correct side cut angle. It is best to lay out the side cut angle on top of the rafter in any case, in order to be sure the tilt at the blade angle is in the right direction to result in the desired side cut.

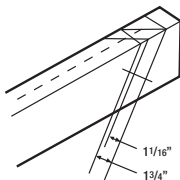

## Using the Stanley Pocket Square (continued)

13) We must now consider the additional length that must be added to the length of the rafter to accommodate the eave. We calculate this by ratios. First, determine the length of common and hip/valley rafters for this pitch roof. In our example, the rafter length is 12' 6". The length of the hip rafter is 16' 1/8". The ratio of hip rafter length to common rafter length is:

$$\frac{16\frac{1}{8}}{12' 6''} = \frac{(16 \times 12) + .125}{(12 \times 12) + 6} = \frac{192.125}{150} = 1.28$$

This ratio or the eave length at the hip or valley rafter divided by the eave length at the common rafter.

$$\frac{D}{C} = 1.28 \text{ where } D \text{ is the length of}$$

the hip or valley eave, and C is the length of the common rafter eave, as shown in the diagram below in our example:

$$\frac{D}{24''} = 1.28, \text{ then } D = 24'' \times 1.28 = 30.72''$$

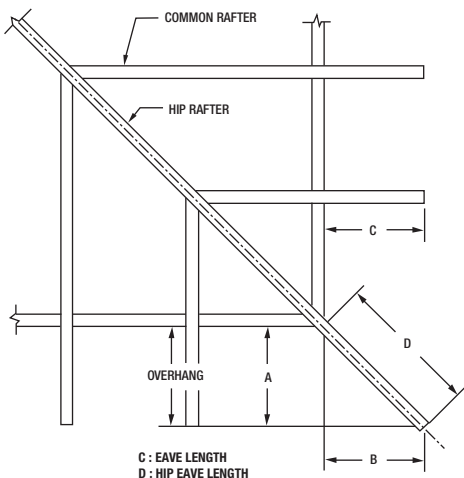

## Using the Stanley Pocket Square (continued)

14) From the squared line across the top at the rafter at the bottom plumb cut line, measure and mark  $30\frac{3}{4}$  inches (eave length). Square this line across the top of the rafter, and mark another bottom plumb cut line on the side of the rafter from this squared line.

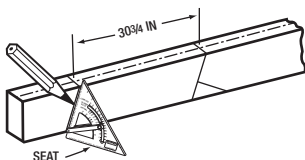

15) Since the length at the hip rafter and valley rafter are measured along the center line on top of the rafter, you can see that the corners at the bottom end of the eave are not in the same plane as the ends of the common rafters.

The cut-off length or the allowance for the mitre is half the thickness of the hip rafter as illustrated below in plan view.

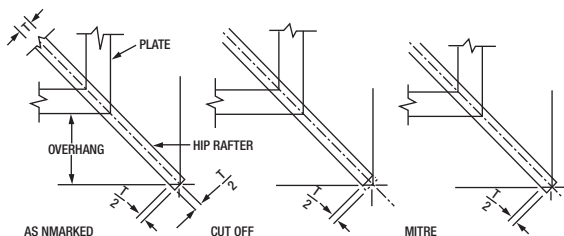

## Using the Stanley Pocket Square (continued)

Some carpenters and roof framers prefer to mark and cut the eave after the hip rafter is in place by snapping a chalk line from the ends of the common rafters.

The cut-off is made along a plumb line laid out from the chalk mark, or as laid out to the calculated length above, with the blade of a portable electric saw set at an angle of 90 degrees to the soleplate.

The mitre cut is made along a plumb line with the blade of a portable electric saw set at an angle of 45 degrees to the soleplate.

16) In the case of the valley rafter, it is not necessary to foreshorten or mitre the end of the rafter since the measured length of the eave (measured along the top of the rafter) lies in the same plane as the ends of the common rafters, as shown in plan view below!

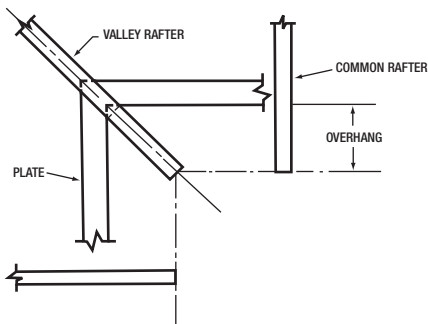

For those who want to make the effort, a 90 degree notch can be made at the bottom at the rafter to provide a better surface for fastening the fascia board. In this case, half the thickness of the valley rafter must be added to the length of the rafter, as illustrated below. A plumb line would again be drawn on the side of the rafter at this point, and with the blade set at 45 degrees on a portable electric saw, and at the proper depth, a cut is made along the plumb line on both sides of the rafter.

## Using the Stanley Pocket Square (continued)

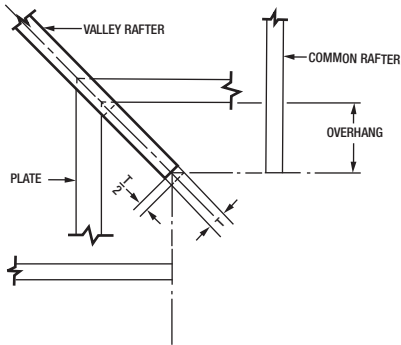

17) When building a hip roof the ridge board should be left about a foot longer than necessary at the ends. Then a common rafter, which has been cut to size, is placed on the center of the end plate, and the upper end positioned alongside the ridge board, aligning the top end of the common rafter with the top of the ridge board.

The ridge board is then marked at the end of the common rafter.

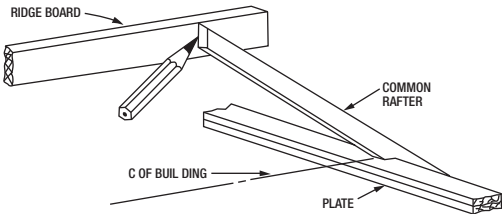

If a center common ridge rafter is used, the ridge board is cut to length at this mark, and the hip rafters are fastened at the top end of the common ridge rafter.

If no center common ridge rafter is used, add 2 inches to the length at the ridge board from the mark just made, to provide a surface to fasten the upper end of the hip rafter, and cut off the ridge board at this point.

## Using the Stanley Pocket Square (continued)

### Jack rafters

Jack rafters tie in the same plane as common rafters, and therefore have the same inch rise per foot run as common rafters.

1) At one end of the rafter, mark the top plumb cut line by setting the pivot of the Stanley **Pocket Square**® on the rafter edge and rotating the square about the pivot point until the edge of the rafter lines up at the '9' on the scale for COM/JACK.

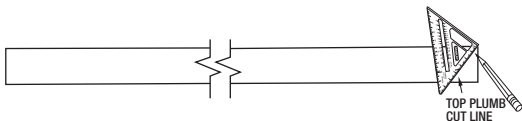

2) Mark a line perpendicular to the top plumb cut line, as shown in figure 4 page 30. Along this line measure and mark the thickness of the rafter.

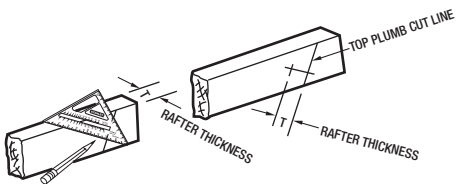

3) Mark a second plumb cut line at this point.

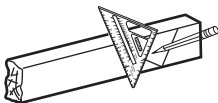



## Using the Stanley Pocket Square (continued)

4) Square the top of the plumb lines across the top of the rafter. Note that in the case of a valley-jack rafter, the top of the rafter is on the 'short' side of the plumb line—that is, just the opposite side of a hipjack!

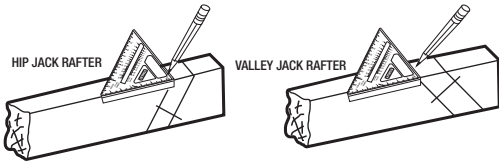

5) Depending on which way the side cut is to be made, connect opposite ends of the square lines.

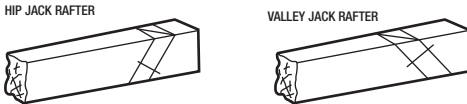

6) From Table 2, "Difference in Length of Jack Rafters for Various Spacing," the length given for 9 inch rise per foot run on 16 inch centers is 1 foot, 8 inches. This is also the length of the first, or shortest, hip-jack or valley-jack rafter. Each succeeding jack rafter will be 1 foot, 8 inches longer than the preceding one!

7) Along the measuring line (the center line on top of the rafter), and from the side cut line marked in Step 5), measure and mark the length of the rafter. The first rafter will be 1 foot, 8 inches long, the second rafter 3 feet, 4 inches long (2 times 1 foot, 8 inches), the third rafter 5 feet, 0 inches (3 times 1 foot, 8 inches), and so on!

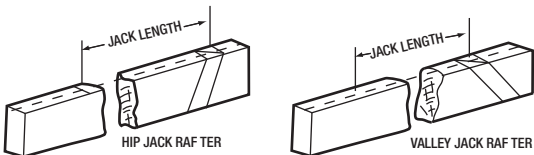

## Using the Stanley Pocket Square (continued)

8) From the length marked, make a plumb cut line on the side of the rafter.

9) For a valley-jack, the rafter will be cut parallel to this line to fit against the ridge board. Be sure this plumb line on the valley-jack is in the same direction as the plumb line at the opposite end of the rafter, that is, parallel to it!

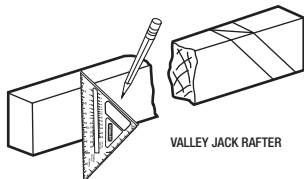

10) For a hip-jack, use a common rafter as a template, and mark the heel and seat cuts (birdsmouth), on the side of the rafter at the bottom plumb cut line. In case there isn't a common rafter available, lay out the heel and seat cut lines as described on page 30 under Seat Cuts.

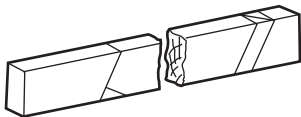

11) Again on a hip-jack, the additional length for the eave is laid out the same as it was for the common rafter. A common rafter may be used as a template, if one is available!

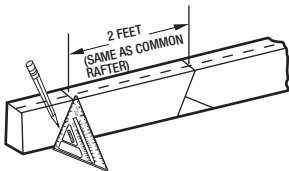

## Using the Stanley Pocket Square (continued)

12) Compensation must now be made for the thickness of the hip or valley rafter in the length of the jack rafter, just as was done for the hip and valley rafter to compensate for the thickness of the ridge board. Mark another plumb cut line  $1\frac{1}{16}$  inch from and parallel to the original plumb cut mark made in Step 1) above. (The  $1\frac{1}{16}$  inch dimension being half the diagonal thickness of the hip or valley rafter).

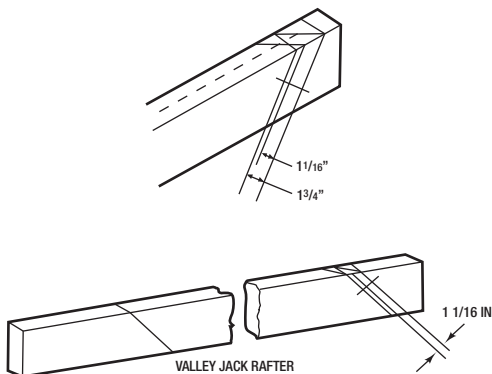

13) From the top of this plumb line, mark a line across the top of the rafter parallel to the side cut mark made in Step No. 6). These last side and plumb cut marks are the marks on which the rafter will be cut. Cutting along this plumb cut line with a portable electric circular saw set at 45 degrees, will result in the correct side cut angle.

## Using the Stanley Pocket Square (continued)

14) A valley-jack rafter must be further reduced in length to compensate for the thickness of the ridge board which it abuts. This is accomplished in the same manner in which the common rafter was shortened, and for the same reason. (Refer to Page 24-Palter Length).

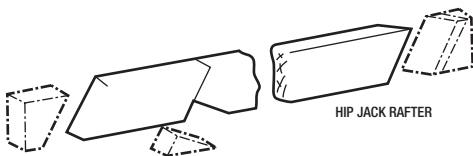
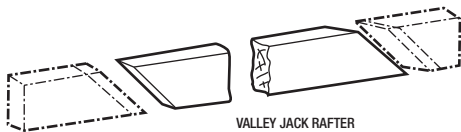
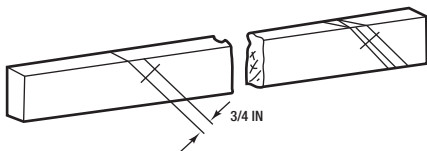

## ADDITIONAL FEATURES AND USES

### Protractor Scale

The Stanley **Pocket Square**® is embossed with a scale, graduated in degrees which makes it very handy for use as protractor. The scale is embossed on both sides of the square body so that either side may be used. The illustration below shows the angles which may be obtained by aligning the pivot and the 30 and 60 degree graduation with the edge.

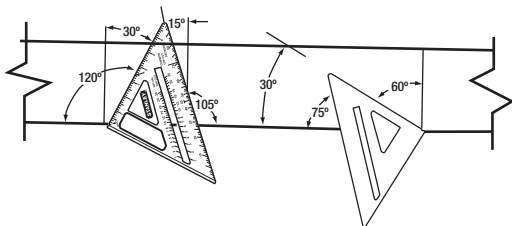

Used in conjunction with a level, the **Pocket Square**® may be used to determine angles of construction members, the rise of existing roofs and rafters, or to adjust a member to any desired angle, as illustrated below.

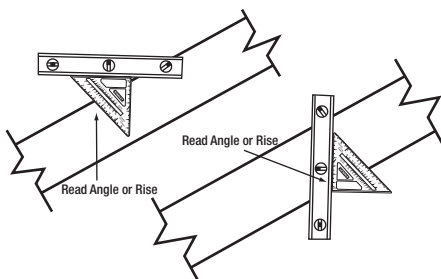

**TABLE 1  
TABLES OF RAFTER LENGTHS**

RISE IN INCHES PER FOOT OF RUN	BUILDING WIDTH			
	3 FEET		4 FEET	
	COMMON FEET-INCHES	HIP-VAL FEET-INCHES	COMMON FEET-INCHES	HIP-VAL FEET-INCHES
1	1-6 <sup>1</sup> / <sub>16</sub>	2-1 <sup>1</sup> / <sub>2</sub>	2-0 <sup>1</sup> / <sub>16</sub>	2-10
2	1-6 <sup>1</sup> / <sub>4</sub>	2-1 <sup>5</sup> / <sub>8</sub>	2-0 <sup>5</sup> / <sub>16</sub>	2-10 <sup>3</sup> / <sub>16</sub>
3	1-6 <sup>9</sup> / <sub>16</sub>	2-1 <sup>7</sup> / <sub>8</sub>	2-0 <sup>3</sup> / <sub>4</sub>	2-10 <sup>7</sup> / <sub>16</sub>
4	1-7	2-2 <sup>1</sup> / <sub>8</sub>	2-1 <sup>5</sup> / <sub>16</sub>	2-10 <sup>7</sup> / <sub>8</sub>
5	1-7 <sup>1</sup> / <sub>2</sub>	2-2 <sup>9</sup> / <sub>16</sub>	2-2	3-11 <sup>3</sup> / <sub>8</sub>
6	1-8 <sup>1</sup> / <sub>8</sub>	2-3	2-2 <sup>13</sup> / <sub>16</sub>	3-0
7	1-8 <sup>13</sup> / <sub>16</sub>	2-3 <sup>9</sup> / <sub>16</sub>	2-3 <sup>13</sup> / <sub>16</sub>	3-0 <sup>11</sup> / <sub>16</sub>
8	1-9 <sup>5</sup> / <sub>8</sub>	2-4 <sup>1</sup> / <sub>8</sub>	2-4 <sup>7</sup> / <sub>8</sub>	3-1 <sup>1</sup> / <sub>2</sub>
9	1-10 <sup>1</sup> / <sub>2</sub>	2-4 <sup>13</sup> / <sub>16</sub>	2-6	3-2 <sup>7</sup> / <sub>16</sub>
10	1-11 <sup>7</sup> / <sub>16</sub>	2-5 <sup>9</sup> / <sub>16</sub>	2-7 <sup>1</sup> / <sub>4</sub>	3-3 <sup>3</sup> / <sub>8</sub>
11	2-0 <sup>7</sup> / <sub>16</sub>	2-6 <sup>5</sup> / <sub>16</sub>	2-8 <sup>9</sup> / <sub>16</sub>	3-4 <sup>7</sup> / <sub>16</sub>
12	2-1 <sup>7</sup> / <sub>16</sub>	2-7 <sup>3</sup> / <sub>16</sub>	2-9 <sup>15</sup> / <sub>16</sub>	3-5 <sup>9</sup> / <sub>16</sub>
	5 FEET		6 FEET	
1	2-6 <sup>1</sup> / <sub>8</sub>	3-6 <sup>1</sup> / <sub>2</sub>	3-0 <sup>1</sup> / <sub>8</sub>	4-3
2	2-6 <sup>7</sup> / <sub>16</sub>	3-6 <sup>3</sup> / <sub>4</sub>	3-0 <sup>1</sup> / <sub>2</sub>	4-3 <sup>1</sup> / <sub>4</sub>
3	2-6 <sup>15</sup> / <sub>16</sub>	3-7 <sup>1</sup> / <sub>16</sub>	3-1 <sup>1</sup> / <sub>8</sub>	4-3 <sup>11</sup> / <sub>16</sub>
4	2-7 <sup>5</sup> / <sub>8</sub>	3-7 <sup>9</sup> / <sub>16</sub>	3-1 <sup>15</sup> / <sub>16</sub>	4-4 <sup>5</sup> / <sub>16</sub>
5	2-8 <sup>1</sup> / <sub>2</sub>	3-8 <sup>1</sup> / <sub>4</sub>	3-3	4-5 <sup>1</sup> / <sub>16</sub>
6	2-9 <sup>9</sup> / <sub>16</sub>	3-9	3-4 <sup>1</sup> / <sub>4</sub>	4-6
7	2-10 <sup>3</sup> / <sub>4</sub>	3-9 <sup>7</sup> / <sub>8</sub>	3-5 <sup>11</sup> / <sub>16</sub>	4-7 <sup>1</sup> / <sub>16</sub>
8	3-0 <sup>1</sup> / <sub>16</sub>	3-10 <sup>7</sup> / <sub>8</sub>	3-7 <sup>1</sup> / <sub>4</sub>	4-8 <sup>5</sup> / <sub>16</sub>
9	3-1 <sup>1</sup> / <sub>2</sub>	4-0	3-9	4-9 <sup>5</sup> / <sub>8</sub>
10	3-3 <sup>1</sup> / <sub>16</sub>	4-1 <sup>1</sup> / <sub>4</sub>	3-10 <sup>7</sup> / <sub>8</sub>	4-11 <sup>1</sup> / <sub>16</sub>
11	3-4 <sup>11</sup> / <sub>16</sub>	4-2 <sup>9</sup> / <sub>16</sub>	4-0 <sup>13</sup> / <sub>16</sub>	5-0 <sup>11</sup> / <sub>16</sub>
12	3-6 <sup>7</sup> / <sub>16</sub>	4-3 <sup>15</sup> / <sub>16</sub>	4-2 <sup>15</sup> / <sub>16</sub>	5-2 <sup>5</sup> / <sub>16</sub>

**TABLE 1  
TABLES OF RAFTER LENGTHS**

RISE IN INCHES PER FOOT OF RUN	BUILDING WIDTH			
	7 FEET		8 FEET	
	COMMON FEET-INCHES	HIP-VAL FEET-INCHES	COMMON FEET-INCHES	HIP-VAL FEET-INCHES
1	3-6 <sup>1</sup> / <sub>8</sub>	4-11 <sup>1</sup> / <sub>2</sub>	4-0 <sup>3</sup> / <sub>16</sub>	5-8
2	3-6 <sup>9</sup> / <sub>16</sub>	4-11 <sup>13</sup> / <sub>16</sub>	4-0 <sup>11</sup> / <sub>16</sub>	5-8 <sup>3</sup> / <sub>8</sub>
3	3-7 <sup>5</sup> / <sub>16</sub>	5-0 <sup>5</sup> / <sub>16</sub>	4-1 <sup>1</sup> / <sub>2</sub>	5-8 <sup>15</sup> / <sub>16</sub>
4	3-8 <sup>1</sup> / <sub>4</sub>	5-1 <sup>1</sup> / <sub>16</sub>	4-2 <sup>5</sup> / <sub>8</sub>	5-9 <sup>3</sup> / <sub>4</sub>
5	3-9 <sup>1</sup> / <sub>2</sub>	5-1 <sup>15</sup> / <sub>16</sub>	4-4	5-10 <sup>3</sup> / <sub>4</sub>
6	3-10 <sup>15</sup> / <sub>16</sub>	5-3	4-5 <sup>11</sup> / <sub>16</sub>	6-0
7	4-0 <sup>5</sup> / <sub>8</sub>	5-4 <sup>1</sup> / <sub>4</sub>	4-7 <sup>9</sup> / <sub>16</sub>	6-1 <sup>7</sup> / <sub>16</sub>
8	4-2 <sup>1</sup> / <sub>2</sub>	5-5 <sup>11</sup> / <sub>16</sub>	4-9 <sup>11</sup> / <sub>16</sub>	6-3 <sup>1</sup> / <sub>16</sub>
9	4-4 <sup>1</sup> / <sub>2</sub>	5-7 <sup>1</sup> / <sub>4</sub>	5-0	6-4 <sup>13</sup> / <sub>16</sub>
10	4-6 <sup>11</sup> / <sub>16</sub>	5-8 <sup>15</sup> / <sub>16</sub>	5-2 <sup>1</sup> / <sub>2</sub>	6-6 <sup>13</sup> / <sub>16</sub>
11	4-9	5-10 <sup>3</sup> / <sub>4</sub>	5-5 <sup>1</sup> / <sub>8</sub>	6-8 <sup>7</sup> / <sub>8</sub>
12	4-11 <sup>3</sup> / <sub>8</sub>	6-0 <sup>3</sup> / <sub>4</sub>	5-7 <sup>7</sup> / <sub>8</sub>	6-11 <sup>1</sup> / <sub>8</sub>
	<b>9 FEET</b>		<b>10 FEET</b>	
1	4-6 <sup>3</sup> / <sub>16</sub>	6-4 <sup>1</sup> / <sub>2</sub>	5-0 <sup>3</sup> / <sub>16</sub>	7-1
2	4-6 <sup>3</sup> / <sub>4</sub>	6-4 <sup>7</sup> / <sub>8</sub>	5-0 <sup>13</sup> / <sub>16</sub>	7-1 <sup>7</sup> / <sub>16</sub>
3	4-7 <sup>11</sup> / <sub>16</sub>	6-5 <sup>9</sup> / <sub>16</sub>	5-1 <sup>7</sup> / <sub>8</sub>	7-2 <sup>1</sup> / <sub>8</sub>
4	4-8 <sup>11</sup> / <sub>16</sub>	6-6 <sup>1</sup> / <sub>2</sub>	5-3 <sup>1</sup> / <sub>4</sub>	7-3 <sup>3</sup> / <sub>16</sub>
5	4-10 <sup>1</sup> / <sub>2</sub>	6-7 <sup>5</sup> / <sub>8</sub>	5-5	7-4 <sup>7</sup> / <sub>16</sub>
6	5-0 <sup>3</sup> / <sub>8</sub>	6-9	5-7 <sup>1</sup> / <sub>16</sub>	7-6
7	5-2 <sup>1</sup> / <sub>2</sub>	6-10 <sup>5</sup> / <sub>8</sub>	5-9 <sup>7</sup> / <sub>16</sub>	7-7 <sup>13</sup> / <sub>16</sub>
8	5-4 <sup>7</sup> / <sub>8</sub>	7-0 <sup>7</sup> / <sub>16</sub>	6-0 <sup>1</sup> / <sub>8</sub>	7-9 <sup>13</sup> / <sub>16</sub>
9	5-7 <sup>1</sup> / <sub>2</sub>	7-2 <sup>7</sup> / <sub>16</sub>	6-3	8-0 <sup>1</sup> / <sub>16</sub>
10	5-10 <sup>5</sup> / <sub>16</sub>	7-4 <sup>5</sup> / <sub>8</sub>	6-6 <sup>1</sup> / <sub>8</sub>	8-2 <sup>1</sup> / <sub>2</sub>
11	6-1 <sup>1</sup> / <sub>4</sub>	7-7	6-9 <sup>3</sup> / <sub>8</sub>	8-5 <sup>1</sup> / <sub>8</sub>
12	6-4 <sup>3</sup> / <sub>8</sub>	7-9 <sup>1</sup> / <sub>2</sub>	7-0 <sup>7</sup> / <sub>8</sub>	8-7 <sup>15</sup> / <sub>16</sub>

**TABLE 1**  
**TABLES OF RAFTER LENGTHS**

RISE IN INCHES PER FOOT OF RUN	BUILDING WIDTH			
	11 FEET		12 FEET	
	COMMON FEET-INCHES	HIP-VAL FEET-INCHES	COMMON FEET-INCHES	HIP-VAL FEET-INCHES
1	5-6 <sup>1</sup> / <sub>4</sub>	7-9 <sup>1</sup> / <sub>2</sub>	6-0 <sup>1</sup> / <sub>4</sub>	8-6
2	5-6 <sup>15</sup> / <sub>16</sub>	7-10	6-1	8-6 <sup>1</sup> / <sub>2</sub>
3	5-8	7-10 <sup>13</sup> / <sub>16</sub>	6-2 <sup>3</sup> / <sub>16</sub>	8-7 <sup>3</sup> / <sub>8</sub>
4	5-9 <sup>9</sup> / <sub>16</sub>	7-11 <sup>7</sup> / <sub>8</sub>	6-3 <sup>7</sup> / <sub>8</sub>	8-8 <sup>5</sup> / <sub>8</sub>
5	5-11 <sup>1</sup> / <sub>2</sub>	8-1 <sup>5</sup> / <sub>16</sub>	6-6	8-10 <sup>1</sup> / <sub>8</sub>
6	4-1 <sup>13</sup> / <sub>16</sub>	8-3	6-8 <sup>1</sup> / <sub>2</sub>	9-0
7	6-4 <sup>7</sup> / <sub>16</sub>	8-4 <sup>15</sup> / <sub>16</sub>	6-11 <sup>3</sup> / <sub>8</sub>	9-2 <sup>1</sup> / <sub>8</sub>
8	6-7 <sup>5</sup> / <sub>16</sub>	8-7 <sup>3</sup> / <sub>16</sub>	7-2 <sup>9</sup> / <sub>16</sub>	9-4 <sup>9</sup> / <sub>16</sub>
9	6-10 <sup>1</sup> / <sub>2</sub>	8-9 <sup>5</sup> / <sub>8</sub>	7-6	9-7 <sup>1</sup> / <sub>4</sub>
10	7-1 <sup>15</sup> / <sub>16</sub>	9-0 <sup>5</sup> / <sub>16</sub>	7-9 <sup>3</sup> / <sub>4</sub>	9-10 <sup>3</sup> / <sub>16</sub>
11	7-5 <sup>9</sup> / <sub>16</sub>	9-3 <sup>1</sup> / <sub>4</sub>	8-1 <sup>11</sup> / <sub>16</sub>	10-1 <sup>5</sup> / <sub>16</sub>
12	7-9 <sup>5</sup> / <sub>16</sub>	9-6 <sup>5</sup> / <sub>16</sub>	8-5 <sup>13</sup> / <sub>16</sub>	10-4 <sup>11</sup> / <sub>16</sub>
	13 FEET		14 FEET	
1	6-6 <sup>1</sup> / <sub>4</sub>	9-2 <sup>1</sup> / <sub>2</sub>	7-0 <sup>5</sup> / <sub>16</sub>	9-11
2	6-7 <sup>1</sup> / <sub>16</sub>	9-3 <sup>1</sup> / <sub>16</sub>	7-1 <sup>3</sup> / <sub>16</sub>	9-11 <sup>5</sup> / <sub>8</sub>
3	6-8 <sup>3</sup> / <sub>8</sub>	9-4	7-2 <sup>9</sup> / <sub>16</sub>	10-0 <sup>5</sup> / <sub>8</sub>
4	6-10 <sup>1</sup> / <sub>4</sub>	9-5 <sup>5</sup> / <sub>16</sub>	7-4 <sup>9</sup> / <sub>16</sub>	10-2 <sup>1</sup> / <sub>16</sub>
5	7-0 <sup>1</sup> / <sub>2</sub>	9-7	7-7	10-3 <sup>13</sup> / <sub>16</sub>
6	7-3 <sup>3</sup> / <sub>16</sub>	9-9	7-9 <sup>15</sup> / <sub>16</sub>	10-6
7	7-6 <sup>5</sup> / <sub>16</sub>	9-11 <sup>5</sup> / <sub>16</sub>	8-1 <sup>1</sup> / <sub>4</sub>	10-8 <sup>1</sup> / <sub>2</sub>
8	7-9 <sup>3</sup> / <sub>4</sub>	10-1 <sup>15</sup> / <sub>16</sub>	8-4 <sup>15</sup> / <sub>16</sub>	10-11 <sup>5</sup> / <sub>16</sub>
9	8-1 <sup>1</sup> / <sub>2</sub>	10-4 <sup>7</sup> / <sub>8</sub>	8-9	11-2 <sup>7</sup> / <sub>16</sub>
10	8-5 <sup>9</sup> / <sub>16</sub>	10-8 <sup>1</sup> / <sub>16</sub>	9-1 <sup>5</sup> / <sub>16</sub>	11-5 <sup>7</sup> / <sub>8</sub>
11	8-9 <sup>13</sup> / <sub>16</sub>	10-11 <sup>7</sup> / <sub>16</sub>	9-5 <sup>15</sup> / <sub>16</sub>	11-9 <sup>9</sup> / <sub>16</sub>
12	9-2 <sup>1</sup> / <sub>16</sub>	11-3 <sup>1</sup> / <sub>8</sub>	9-10 <sup>13</sup> / <sub>16</sub>	12-1 <sup>1</sup> / <sub>2</sub>



**TABLE 1  
TABLES OF RAFTER LENGTHS**

RISE IN INCHES PER FOOT OF RUN	BUILDING WIDTH			
	15 FEET		16 FEET	
	COMMON FEET-INCHES	HIP-VAL FEET-INCHES	COMMON FEET-INCHES	HIP-VAL FEET-INCHES
1	7-6 <sup>5</sup> / <sub>16</sub>	10-7 <sup>1</sup> / <sub>2</sub>	8-0 <sup>5</sup> / <sub>16</sub>	11-4
2	7-7 <sup>1</sup> / <sub>4</sub>	10-8 <sup>3</sup> / <sub>16</sub>	8-1 <sup>5</sup> / <sub>16</sub>	11-4 <sup>11</sup> / <sub>16</sub>
3	7-8 <sup>3</sup> / <sub>4</sub>	10-9 <sup>1</sup> / <sub>4</sub>	8-2 <sup>15</sup> / <sub>16</sub>	11-5 <sup>7</sup> / <sub>8</sub>
4	7-10 <sup>7</sup> / <sub>8</sub>	10-10 <sup>3</sup> / <sub>4</sub>	8-5 <sup>3</sup> / <sub>16</sub>	11-7 <sup>1</sup> / <sub>2</sub>
5	8-1 <sup>1</sup> / <sub>2</sub>	11-0 <sup>11</sup> / <sub>16</sub>	8-8	11-9 <sup>9</sup> / <sub>16</sub>
6	8-4 <sup>5</sup> / <sub>8</sub>	11-3	8-11 <sup>5</sup> / <sub>16</sub>	12-0
7	8-8 <sup>3</sup> / <sub>16</sub>	11-5 <sup>11</sup> / <sub>16</sub>	9-3 <sup>1</sup> / <sub>8</sub>	12-2 <sup>7</sup> / <sub>8</sub>
8	9-0 <sup>3</sup> / <sub>16</sub>	11-8 <sup>11</sup> / <sub>16</sub>	9-7 <sup>3</sup> / <sub>8</sub>	12-6 <sup>1</sup> / <sub>16</sub>
9	9-4 <sup>1</sup> / <sub>2</sub>	12-0 <sup>1</sup> / <sub>16</sub>	10-0	12-9 <sup>11</sup> / <sub>16</sub>
10	9-9 <sup>1</sup> / <sub>8</sub>	12-3 <sup>3</sup> / <sub>4</sub>	10-4 <sup>15</sup> / <sub>16</sub>	13-1 <sup>9</sup> / <sub>16</sub>
11	10-2 <sup>1</sup> / <sub>16</sub>	12-7 <sup>11</sup> / <sub>16</sub>	10-10 <sup>1</sup> / <sub>4</sub>	13-5 <sup>13</sup> / <sub>16</sub>
12	10-7 <sup>1</sup> / <sub>4</sub>	12-11 <sup>7</sup> / <sub>8</sub>	11-3 <sup>3</sup> / <sub>4</sub>	13-10 <sup>1</sup> / <sub>4</sub>
	<b>17 FEET</b>		<b>18 FEET</b>	
1	8-6 <sup>3</sup> / <sub>8</sub>	12-0 <sup>1</sup> / <sub>2</sub>	9-0 <sup>3</sup> / <sub>8</sub>	12-9
2	8-7 <sup>7</sup> / <sub>16</sub>	12-1 <sup>1</sup> / <sub>4</sub>	9-1 <sup>1</sup> / <sub>2</sub>	12-9 <sup>13</sup> / <sub>16</sub>
3	8-9 <sup>1</sup> / <sub>8</sub>	12-2 <sup>1</sup> / <sub>2</sub>	9-3 <sup>5</sup> / <sub>16</sub>	12-11 <sup>1</sup> / <sub>8</sub>
4	8-11 <sup>1</sup> / <sub>2</sub>	12-4 <sup>3</sup> / <sub>16</sub>	9-5 <sup>13</sup> / <sub>16</sub>	13-0 <sup>15</sup> / <sub>16</sub>
5	9-2 <sup>1</sup> / <sub>2</sub>	12-6 <sup>3</sup> / <sub>8</sub>	9-9	13-3 <sup>1</sup> / <sub>4</sub>
6	9-6 <sup>1</sup> / <sub>16</sub>	12-9	10-0 <sup>3</sup> / <sub>4</sub>	13-6
7	9-10 <sup>1</sup> / <sub>16</sub>	13-0 <sup>1</sup> / <sub>16</sub>	10-5 <sup>1</sup> / <sub>16</sub>	13-9 <sup>3</sup> / <sub>16</sub>
8	10-2 <sup>9</sup> / <sub>16</sub>	13-3 <sup>1</sup> / <sub>2</sub>	10-9 <sup>13</sup> / <sub>16</sub>	14-0 <sup>7</sup> / <sub>8</sub>
9	10-7 <sup>1</sup> / <sub>2</sub>	13-7 <sup>1</sup> / <sub>4</sub>	11-3	14-4 <sup>7</sup> / <sub>8</sub>
10	11-0 <sup>3</sup> / <sub>4</sub>	13-1 <sup>7</sup> / <sub>16</sub>	11-8 <sup>9</sup> / <sub>16</sub>	14-9 <sup>1</sup> / <sub>4</sub>
11	11-6 <sup>3</sup> / <sub>8</sub>	14-3 <sup>7</sup> / <sub>8</sub>	12-2 <sup>1</sup> / <sub>2</sub>	15-2
12	12-0 <sup>1</sup> / <sub>4</sub>	14-8 <sup>11</sup> / <sub>16</sub>	12-8 <sup>3</sup> / <sub>4</sub>	15-7 <sup>1</sup> / <sub>16</sub>

**TABLE 1  
TABLES OF RAFTER LENGTHS**

RISE IN INCHES PER FOOT OF RUN	BUILDING WIDTH			
	19 FEET		20 FEET	
	COMMON FEET-INCHES	HIP-VAL FEET-INCHES	COMMON FEET-INCHES	HIP-VAL FEET-INCHES
1	9-6 <sup>3</sup> / <sub>8</sub>	13-5 <sup>1</sup> / <sub>2</sub>	10-0 <sup>7</sup> / <sub>16</sub>	14-2
2	9-7 <sup>9</sup> / <sub>16</sub>	13-6 <sup>5</sup> / <sub>16</sub>	10-1 <sup>5</sup> / <sub>8</sub>	14-2 <sup>7</sup> / <sub>8</sub>
3	9-9 <sup>1</sup> / <sub>2</sub>	13-7 <sup>3</sup> / <sub>4</sub>	10-3 <sup>11</sup> / <sub>16</sub>	14-4 <sup>5</sup> / <sub>16</sub>
4	10-0 <sup>3</sup> / <sub>16</sub>	13-9 <sup>5</sup> / <sub>8</sub>	10-6 <sup>1</sup> / <sub>2</sub>	14-6 <sup>3</sup> / <sub>8</sub>
5	10-3 <sup>1</sup> / <sub>2</sub>	14-0 <sup>1</sup> / <sub>16</sub>	10-10	14-8 <sup>15</sup> / <sub>16</sub>
6	10-7 <sup>7</sup> / <sub>16</sub>	14-3	11-2 <sup>3</sup> / <sub>16</sub>	15-0
7	11-0	14-6 <sup>3</sup> / <sub>8</sub>	11-6 <sup>15</sup> / <sub>16</sub>	15-3 <sup>9</sup> / <sub>16</sub>
8	11-5	14-10 <sup>1</sup> / <sub>4</sub>	12-0 <sup>1</sup> / <sub>4</sub>	15-7 <sup>5</sup> / <sub>8</sub>
9	11-10 <sup>1</sup> / <sub>2</sub>	15-2 <sup>1</sup> / <sub>2</sub>	12-6	16-0 <sup>1</sup> / <sub>8</sub>
10	12-4 <sup>3</sup> / <sub>8</sub>	15-7 <sup>1</sup> / <sub>16</sub>	13-0 <sup>3</sup> / <sub>16</sub>	16-5
11	12-10 <sup>5</sup> / <sub>8</sub>	16-0 <sup>1</sup> / <sub>16</sub>	13-6 <sup>13</sup> / <sub>16</sub>	16-10 <sup>1</sup> / <sub>4</sub>
12	13-5 <sup>1</sup> / <sub>4</sub>	16-5 <sup>7</sup> / <sub>16</sub>	14-1 <sup>11</sup> / <sub>16</sub>	17-3 <sup>7</sup> / <sub>8</sub>
	<b>21 FEET</b>		<b>22 FEET</b>	
1	10-6 <sup>7</sup> / <sub>16</sub>	14-10 <sup>1</sup> / <sub>2</sub>	11-0 <sup>7</sup> / <sub>16</sub>	15-7
2	10-7 <sup>3</sup> / <sub>4</sub>	14-11 <sup>7</sup> / <sub>16</sub>	11-1 <sup>13</sup> / <sub>16</sub>	15-7 <sup>15</sup> / <sub>16</sub>
3	10-9 <sup>7</sup> / <sub>8</sub>	15-0 <sup>15</sup> / <sub>16</sub>	11-4 <sup>1</sup> / <sub>16</sub>	15-9 <sup>9</sup> / <sub>16</sub>
4	11-0 <sup>13</sup> / <sub>16</sub>	15-3 <sup>1</sup> / <sub>16</sub>	11-7 <sup>1</sup> / <sub>8</sub>	15-11 <sup>13</sup> / <sub>16</sub>
5	11-4 <sup>1</sup> / <sub>2</sub>	15-5 <sup>3</sup> / <sub>4</sub>	11-11	16-2 <sup>5</sup> / <sub>8</sub>
6	11-8 <sup>7</sup> / <sub>8</sub>	15-9	12-3 <sup>9</sup> / <sub>16</sub>	16-6
7	12-1 <sup>7</sup> / <sub>8</sub>	16-0 <sup>3</sup> / <sub>4</sub>	12-8 <sup>13</sup> / <sub>16</sub>	16-9 <sup>15</sup> / <sub>16</sub>
8	12-7 <sup>7</sup> / <sub>16</sub>	16-5	13-2 <sup>5</sup> / <sub>8</sub>	17-2 <sup>3</sup> / <sub>8</sub>
9	13-1 <sup>1</sup> / <sub>2</sub>	16-9 <sup>11</sup> / <sub>16</sub>	13-9	17-7 <sup>5</sup> / <sub>16</sub>
10	13-8	17-2 <sup>13</sup> / <sub>16</sub>	14-3 <sup>13</sup> / <sub>16</sub>	18-0 <sup>11</sup> / <sub>16</sub>
11	14-2 <sup>15</sup> / <sub>16</sub>	17-8 <sup>3</sup> / <sub>8</sub>	14-11 <sup>1</sup> / <sub>16</sub>	18-6 <sup>7</sup> / <sub>16</sub>
12	14-10 <sup>3</sup> / <sub>16</sub>	18-2 <sup>1</sup> / <sub>4</sub>	15-6 <sup>11</sup> / <sub>16</sub>	19-0 <sup>5</sup> / <sub>8</sub>

**TABLE 1  
TABLES OF RAFTER LENGTHS**

RISE IN INCHES PER FOOT OF RUN	BUILDING WIDTH			
	23 FEET		24 FEET	
	COMMON FEET-INCHES	HIP-VAL FEET-INCHES	COMMON FEET-INCHES	HIP-VAL FEET-INCHES
1	11-6 <sup>1</sup> / <sub>2</sub>	16-3 <sup>1</sup> / <sub>2</sub>	12-0 <sup>1</sup> / <sub>2</sub>	17-0
2	11-7 <sup>7</sup> / <sub>8</sub>	16-4 <sup>1</sup> / <sub>2</sub>	12-2	17-1 <sup>1</sup> / <sub>16</sub>
3	11-10 <sup>1</sup> / <sub>4</sub>	16-6 <sup>3</sup> / <sub>16</sub>	12-4 <sup>7</sup> / <sub>16</sub>	17-2 <sup>13</sup> / <sub>16</sub>
4	12-1 <sup>7</sup> / <sub>16</sub>	16-8 <sup>1</sup> / <sub>2</sub>	12-7 <sup>13</sup> / <sub>16</sub>	17-5 <sup>1</sup> / <sub>4</sub>
5	12-5 <sup>1</sup> / <sub>2</sub>	16-11 <sup>7</sup> / <sub>16</sub>	13-0	17-8 <sup>5</sup> / <sub>16</sub>
6	12-10 <sup>5</sup> / <sub>16</sub>	17-3	13-5	18-0
7	13-3 <sup>3</sup> / <sub>4</sub>	17-7 <sup>1</sup> / <sub>8</sub>	13-10 <sup>11</sup> / <sub>16</sub>	18-4 <sup>5</sup> / <sub>16</sub>
8	13-9 <sup>7</sup> / <sub>8</sub>	17-11 <sup>3</sup> / <sub>4</sub>	14-5 <sup>1</sup> / <sub>16</sub>	18-9 <sup>1</sup> / <sub>8</sub>
9	14-4 <sup>1</sup> / <sub>2</sub>	18-4 <sup>15</sup> / <sub>16</sub>	15-0	19-2 <sup>1</sup> / <sub>2</sub>
10	14-1 <sup>5</sup> / <sub>8</sub>	18-10 <sup>1</sup> / <sub>2</sub>	15-7 <sup>7</sup> / <sub>16</sub>	19-8 <sup>3</sup> / <sub>8</sub>
11	15-7 <sup>3</sup> / <sub>16</sub>	19-4 <sup>9</sup> / <sub>16</sub>	16-3 <sup>3</sup> / <sub>8</sub>	20-2 <sup>11</sup> / <sub>16</sub>
12	16-3 <sup>3</sup> / <sub>16</sub>	19-11	16-11 <sup>5</sup> / <sub>8</sub>	20-9 <sup>7</sup> / <sub>16</sub>
	<b>25 FEET</b>		<b>26 FEET</b>	
1	12-6 <sup>1</sup> / <sub>2</sub>	17-8 <sup>1</sup> / <sub>2</sub>	13-0 <sup>9</sup> / <sub>16</sub>	18-5
2	12-8 <sup>1</sup> / <sub>16</sub>	17-9 <sup>5</sup> / <sub>8</sub>	13-2 <sup>1</sup> / <sub>8</sub>	18-6 <sup>1</sup> / <sub>8</sub>
3	12-10 <sup>5</sup> / <sub>8</sub>	17-11 <sup>7</sup> / <sub>16</sub>	13-4 <sup>13</sup> / <sub>16</sub>	18-8 <sup>1</sup> / <sub>16</sub>
4	13-2 <sup>1</sup> / <sub>8</sub>	18-1 <sup>15</sup> / <sub>16</sub>	13-8 <sup>7</sup> / <sub>16</sub>	18-10 <sup>11</sup> / <sub>16</sub>
5	13-6 <sup>1</sup> / <sub>2</sub>	18-5 <sup>1</sup> / <sub>8</sub>	14-1	19-2
6	13-11 <sup>11</sup> / <sub>16</sub>	18-9	14-6 <sup>7</sup> / <sub>16</sub>	19-6
7	14-5 <sup>5</sup> / <sub>8</sub>	19-1 <sup>1</sup> / <sub>2</sub>	15-0 <sup>5</sup> / <sub>8</sub>	19-10 <sup>5</sup> / <sub>8</sub>
8	15-0 <sup>1</sup> / <sub>4</sub>	19-6 <sup>1</sup> / <sub>2</sub>	15-7 <sup>1</sup> / <sub>2</sub>	20-3 <sup>7</sup> / <sub>8</sub>
9	15-7 <sup>1</sup> / <sub>2</sub>	20-0 <sup>1</sup> / <sub>8</sub>	16-3	20-9 <sup>3</sup> / <sub>4</sub>
10	16-3 <sup>1</sup> / <sub>4</sub>	20-6 <sup>1</sup> / <sub>4</sub>	16-11 <sup>1</sup> / <sub>16</sub>	21-4 <sup>1</sup> / <sub>16</sub>
11	16-11 <sup>1</sup> / <sub>2</sub>	21-0 <sup>13</sup> / <sub>16</sub>	17-7 <sup>5</sup> / <sub>8</sub>	21-10 <sup>15</sup> / <sub>16</sub>
12	17-8 <sup>1</sup> / <sub>8</sub>	21-7 <sup>13</sup> / <sub>16</sub>	18-4 <sup>5</sup> / <sub>8</sub>	22-6 <sup>3</sup> / <sub>16</sub>

**TABLE 1  
TABLES OF RAFTER LENGTHS**

RISE IN INCHES PER FOOT OF RUN	BUILDING WIDTH			
	27 FEET		28 FEET	
	COMMON FEET-INCHES	HIP-VAL FEET-INCHES	COMMON FEET-INCHES	HIP-VAL FEET-INCHES
1	13-6 <sup>9</sup> / <sub>16</sub>	19-1 <sup>1</sup> / <sub>2</sub>	14-0 <sup>9</sup> / <sub>16</sub>	19-10
2	13-8 <sup>1</sup> / <sub>4</sub>	19-2 <sup>11</sup> / <sub>16</sub>	14-2 <sup>5</sup> / <sub>16</sub>	19-11 <sup>1</sup> / <sub>4</sub>
3	13-11	19-4 <sup>5</sup> / <sub>8</sub>	14-5 <sup>3</sup> / <sub>16</sub>	20-1 <sup>1</sup> / <sub>4</sub>
4	14-2 <sup>3</sup> / <sub>4</sub>	19-7 <sup>3</sup> / <sub>8</sub>	14-9 <sup>1</sup> / <sub>16</sub>	20-4 <sup>1</sup> / <sub>8</sub>
5	14-7 <sup>1</sup> / <sub>2</sub>	19-10 <sup>13</sup> / <sub>16</sub>	15-2	20-7 <sup>11</sup> / <sub>16</sub>
6	15-1 <sup>1</sup> / <sub>8</sub>	20-3	15-7 <sup>13</sup> / <sub>16</sub>	21-0
7	15-7 <sup>9</sup> / <sub>16</sub>	20-7 <sup>13</sup> / <sub>16</sub>	16-2 <sup>1</sup> / <sub>2</sub>	21-5
8	16-2 <sup>11</sup> / <sub>16</sub>	21-1 <sup>5</sup> / <sub>16</sub>	16-9 <sup>15</sup> / <sub>16</sub>	21-10 <sup>11</sup> / <sub>16</sub>
9	16-10 <sup>1</sup> / <sub>2</sub>	21-7 <sup>5</sup> / <sub>16</sub>	17-6	22-4 <sup>15</sup> / <sub>16</sub>
10	17-6 <sup>7</sup> / <sub>8</sub>	22-1 <sup>15</sup> / <sub>16</sub>	18-2 <sup>11</sup> / <sub>16</sub>	22-11 <sup>3</sup> / <sub>4</sub>
11	18-3 <sup>3</sup> / <sub>4</sub>	22-9	18-11 <sup>7</sup> / <sub>8</sub>	23-7 <sup>1</sup> / <sub>8</sub>
12	19-1 <sup>1</sup> / <sub>8</sub>	23-4 <sup>9</sup> / <sub>16</sub>	19-9 <sup>9</sup> / <sub>16</sub>	24-3
	<b>29 FEET</b>		<b>30 FEET</b>	
1	14-6 <sup>5</sup> / <sub>8</sub>	20-6 <sup>1</sup> / <sub>2</sub>	15-0 <sup>5</sup> / <sub>8</sub>	21-3
2	14-8 <sup>3</sup> / <sub>8</sub>	20-7 <sup>3</sup> / <sub>4</sub>	15-2 <sup>1</sup> / <sub>2</sub>	21-4 <sup>5</sup> / <sub>16</sub>
3	14-11 <sup>3</sup> / <sub>8</sub>	20-9 <sup>7</sup> / <sub>8</sub>	15-5 <sup>9</sup> / <sub>16</sub>	21-6 <sup>1</sup> / <sub>2</sub>
4	15-3 <sup>7</sup> / <sub>16</sub>	21-0 <sup>13</sup> / <sub>16</sub>	15-9 <sup>3</sup> / <sub>4</sub>	21-9 <sup>9</sup> / <sub>16</sub>
5	15-8 <sup>1</sup> / <sub>2</sub>	21-4 <sup>9</sup> / <sub>16</sub>	16-3	22-1 <sup>3</sup> / <sub>8</sub>
6	16-2 <sup>9</sup> / <sub>16</sub>	21-9	16-9 <sup>1</sup> / <sub>4</sub>	22-6
7	16-9 <sup>7</sup> / <sub>16</sub>	22-2 <sup>3</sup> / <sub>16</sub>	17-4 <sup>3</sup> / <sub>8</sub>	22-11 <sup>3</sup> / <sub>8</sub>
8	17-5 <sup>1</sup> / <sub>8</sub>	22-8 <sup>1</sup> / <sub>16</sub>	18-0 <sup>5</sup> / <sub>16</sub>	23-5 <sup>7</sup> / <sub>16</sub>
9	18-1 <sup>1</sup> / <sub>2</sub>	23-2 <sup>9</sup> / <sub>16</sub>	18-9	24-0 <sup>1</sup> / <sub>8</sub>
10	18-10 <sup>1</sup> / <sub>2</sub>	23-9 <sup>5</sup> / <sub>8</sub>	19-6 <sup>5</sup> / <sub>16</sub>	24-7 <sup>7</sup> / <sub>16</sub>
11	19-8 <sup>1</sup> / <sub>16</sub>	24-5 <sup>1</sup> / <sub>4</sub>	20-4 <sup>3</sup> / <sub>16</sub>	25-3 <sup>3</sup> / <sub>8</sub>
12	20-6 <sup>1</sup> / <sub>16</sub>	25-1 <sup>3</sup> / <sub>8</sub>	21-2 <sup>9</sup> / <sub>16</sub>	25-11 <sup>3</sup> / <sub>4</sub>

**TABLE 1  
TABLES OF RAFTER LENGTHS**

RISE IN INCHES PER FOOT OF RUN	BUILDING WIDTH			
	31 FEET		32 FEET	
	COMMON FEET-INCHES	HIP-VAL FEET-INCHES	COMMON FEET-INCHES	HIP-VAL FEET-INCHES
1	15-6 <sup>5</sup> / <sub>8</sub>	21-11 <sup>1</sup> / <sub>2</sub>	16-0 <sup>11</sup> / <sub>16</sub>	22-8
2	15-8 <sup>9</sup> / <sub>16</sub>	22-0 <sup>7</sup> / <sub>8</sub>	16-2 <sup>5</sup> / <sub>8</sub>	22-9 <sup>7</sup> / <sub>16</sub>
3	15-1 <sup>3</sup> / <sub>4</sub>	22-3 <sup>1</sup> / <sub>8</sub>	16-5 <sup>15</sup> / <sub>16</sub>	22-11 <sup>3</sup> / <sub>4</sub>
4	16-4 <sup>1</sup> / <sub>16</sub>	22-6 <sup>1</sup> / <sub>4</sub>	16-10 <sup>3</sup> / <sub>8</sub>	23-3
5	16-9 <sup>1</sup> / <sub>2</sub>	22-10 <sup>1</sup> / <sub>4</sub>	17-4	23-7 <sup>1</sup> / <sub>16</sub>
6	17-3 <sup>15</sup> / <sub>16</sub>	23-3	17-10 <sup>11</sup> / <sub>16</sub>	24-0
7	17-11 <sup>5</sup> / <sub>16</sub>	23-8 <sup>9</sup> / <sub>16</sub>	18-6 <sup>1</sup> / <sub>4</sub>	24-5 <sup>3</sup> / <sub>4</sub>
8	18-7 <sup>9</sup> / <sub>16</sub>	24-2 <sup>13</sup> / <sub>16</sub>	19-2 <sup>3</sup> / <sub>4</sub>	25-0 <sup>3</sup> / <sub>16</sub>
9	19-4 <sup>1</sup> / <sub>2</sub>	24-9 <sup>3</sup> / <sub>4</sub>	20-0	25-7 <sup>3</sup> / <sub>8</sub>
10	20-2 <sup>1</sup> / <sub>8</sub>	25-5 <sup>7</sup> / <sub>16</sub>	20-9 <sup>15</sup> / <sub>16</sub>	26-3 <sup>3</sup> / <sub>16</sub>
11	21-0 <sup>5</sup> / <sub>16</sub>	26-1 <sup>1</sup> / <sub>16</sub>	21-8 <sup>7</sup> / <sub>16</sub>	26-11 <sup>9</sup> / <sub>16</sub>
12	21-1 <sup>1</sup> / <sub>16</sub>	26-10 <sup>3</sup> / <sub>16</sub>	22-7 <sup>1</sup> / <sub>2</sub>	27-8 <sup>9</sup> / <sub>16</sub>
	<b>33 FEET</b>		<b>34 FEET</b>	
1	16-6 <sup>11</sup> / <sub>16</sub>	23-4 <sup>1</sup> / <sub>2</sub>	17-0 <sup>11</sup> / <sub>16</sub>	24-1
2	16-8 <sup>3</sup> / <sub>4</sub>	23-5 <sup>15</sup> / <sub>16</sub>	17-2 <sup>13</sup> / <sub>16</sub>	24-2 <sup>1</sup> / <sub>2</sub>
3	17-0 <sup>1</sup> / <sub>16</sub>	23-8 <sup>3</sup> / <sub>8</sub>	17-6 <sup>1</sup> / <sub>4</sub>	24-5
4	17-4 <sup>11</sup> / <sub>16</sub>	23-11 <sup>11</sup> / <sub>16</sub>	17-11 <sup>1</sup> / <sub>16</sub>	24-8 <sup>3</sup> / <sub>8</sub>
5	17-10 <sup>1</sup> / <sub>2</sub>	24-3 <sup>15</sup> / <sub>16</sub>	18-5	25-0 <sup>3</sup> / <sub>4</sub>
6	18-5 <sup>3</sup> / <sub>8</sub>	24-9	19-0 <sup>1</sup> / <sub>16</sub>	25-6
7	19-1 <sup>1</sup> / <sub>4</sub>	25-2 <sup>7</sup> / <sub>8</sub>	19-8 <sup>3</sup> / <sub>16</sub>	26-0 <sup>1</sup> / <sub>16</sub>
8	19-9 <sup>15</sup> / <sub>16</sub>	25-9 <sup>9</sup> / <sub>16</sub>	20-5 <sup>3</sup> / <sub>16</sub>	26-6 <sup>15</sup> / <sub>16</sub>
9	20-7 <sup>1</sup> / <sub>2</sub>	26-4 <sup>15</sup> / <sub>16</sub>	21-3	27-2 <sup>9</sup> / <sub>16</sub>
10	21-5 <sup>3</sup> / <sub>4</sub>	27-1	22-1 <sup>9</sup> / <sub>16</sub>	27-10 <sup>7</sup> / <sub>8</sub>
11	22-4 <sup>5</sup> / <sub>8</sub>	27-4 <sup>11</sup> / <sub>16</sub>	23-0 <sup>3</sup> / <sub>4</sub>	28-7 <sup>13</sup> / <sub>16</sub>
12	23-4	28-6 <sup>15</sup> / <sub>16</sub>	24-0 <sup>1</sup> / <sub>2</sub>	29-5 <sup>5</sup> / <sub>16</sub>

**TABLE 1**  
**TABLES OF RAFTER LENGTHS**

RISE IN INCHES PER FOOT OF RUN	BUILDING WIDTH			
	35 FEET		36 FEET	
	COMMON FEET-INCHES	HIP-VAL FEET-INCHES	COMMON FEET-INCHES	HIP-VAL FEET-INCHES
1	17-6 <sup>3</sup> / <sub>4</sub>	24-9 <sup>1</sup> / <sub>2</sub>	18-0 <sup>3</sup> / <sub>4</sub>	25-6
2	17-8 <sup>7</sup> / <sub>8</sub>	24-11 <sup>1</sup> / <sub>16</sub>	18-3	25-7 <sup>9</sup> / <sub>16</sub>
3	18-0 <sup>7</sup> / <sub>16</sub>	25-1 <sup>9</sup> / <sub>16</sub>	18-6 <sup>5</sup> / <sub>8</sub>	25-10 <sup>3</sup> / <sub>16</sub>
4	18-5 <sup>3</sup> / <sub>8</sub>	25-5 <sup>1</sup> / <sub>8</sub>	18-11 <sup>11</sup> / <sub>16</sub>	26-1 <sup>13</sup> / <sub>16</sub>
5	18-11 <sup>1</sup> / <sub>2</sub>	25-9 <sup>5</sup> / <sub>8</sub>	19-6	26-6 <sup>7</sup> / <sub>16</sub>
6	19-6 <sup>13</sup> / <sub>16</sub>	26-3	20-1 <sup>1</sup> / <sub>2</sub>	27-0
7	20-3 <sup>1</sup> / <sub>8</sub>	26-9 <sup>1</sup> / <sub>4</sub>	20-10 <sup>1</sup> / <sub>16</sub>	27-6 <sup>7</sup> / <sub>16</sub>
8	21-0 <sup>3</sup> / <sub>8</sub>	27-4 <sup>5</sup> / <sub>16</sub>	21-7 <sup>5</sup> / <sub>8</sub>	28-1 <sup>11</sup> / <sub>16</sub>
9	21-10 <sup>1</sup> / <sub>2</sub>	28-0 <sup>3</sup> / <sub>16</sub>	22-6	28-9 <sup>3</sup> / <sub>4</sub>
10	22-9 <sup>3</sup> / <sub>8</sub>	28-8 <sup>11</sup> / <sub>16</sub>	23-5 <sup>3</sup> / <sub>16</sub>	29-6 <sup>9</sup> / <sub>16</sub>
11	23-8 <sup>7</sup> / <sub>8</sub>	29-5 <sup>15</sup> / <sub>16</sub>	24-5	30-4
12	24-9	30-3 <sup>3</sup> / <sub>4</sub>	25-5 <sup>1</sup> / <sub>2</sub>	31-2 <sup>1</sup> / <sub>8</sub>
	37 FEET		38 FEET	
1	18-6 <sup>3</sup> / <sub>4</sub>	26-2 <sup>1</sup> / <sub>2</sub>	19-0 <sup>13</sup> / <sub>16</sub>	26-11
2	18-9 <sup>1</sup> / <sub>16</sub>	26-4 <sup>1</sup> / <sub>8</sub>	19-3 <sup>1</sup> / <sub>8</sub>	27-0 <sup>11</sup> / <sub>16</sub>
3	19-0 <sup>13</sup> / <sub>16</sub>	26-6 <sup>13</sup> / <sub>16</sub>	19-7	27-3 <sup>7</sup> / <sub>16</sub>
4	19-6	26-10 <sup>9</sup> / <sub>16</sub>	20-0 <sup>5</sup> / <sub>16</sub>	27-7 <sup>1</sup> / <sub>4</sub>
5	20-0 <sup>1</sup> / <sub>2</sub>	27-3 <sup>5</sup> / <sub>16</sub>	20-7	28-0 <sup>1</sup> / <sub>8</sub>
6	20-8 <sup>3</sup> / <sub>16</sub>	27-9	21-2 <sup>15</sup> / <sub>16</sub>	28-6
7	21-5	28-3 <sup>5</sup> / <sub>8</sub>	21-11 <sup>15</sup> / <sub>16</sub>	29-0 <sup>13</sup> / <sub>16</sub>
8	22-2 <sup>13</sup> / <sub>16</sub>	28-11 <sup>1</sup> / <sub>16</sub>	22-10	29-8 <sup>1</sup> / <sub>2</sub>
9	23-1 <sup>1</sup> / <sub>2</sub>	29-7 <sup>3</sup> / <sub>8</sub>	23-9	30-5
10	24-1	30-4 <sup>7</sup> / <sub>16</sub>	24-8 <sup>13</sup> / <sub>16</sub>	31-2 <sup>1</sup> / <sub>4</sub>
11	25-1 <sup>3</sup> / <sub>16</sub>	31-2 <sup>1</sup> / <sub>8</sub>	25-9 <sup>5</sup> / <sub>16</sub>	32-0 <sup>1</sup> / <sub>4</sub>
12	26-1 <sup>15</sup> / <sub>16</sub>	32-0 <sup>1</sup> / <sub>2</sub>	26-10 <sup>7</sup> / <sub>16</sub>	32-10 <sup>15</sup> / <sub>16</sub>

**TABLE 1  
TABLES OF RAFTER LENGTHS**

RISE IN INCHES PER FOOT OF RUN	BUILDING WIDTH			
	39 FEET		40 FEET	
	COMMON FEET-INCHES	HIP-VAL FEET-INCHES	COMMON FEET-INCHES	HIP-VAL FEET-INCHES
1	19-6 <sup>13</sup> / <sub>16</sub>	27-7 <sup>1</sup> / <sub>2</sub>	20-0 <sup>13</sup> / <sub>16</sub>	28-4
2	19-9 <sup>1</sup> / <sub>4</sub>	27-9 <sup>3</sup> / <sub>16</sub>	20-3 <sup>5</sup> / <sub>16</sub>	28-5 <sup>3</sup> / <sub>4</sub>
3	20-1 <sup>3</sup> / <sub>16</sub>	28-0 <sup>1</sup> / <sub>16</sub>	20-7 <sup>3</sup> / <sub>8</sub>	28-8 <sup>11</sup> / <sub>16</sub>
4	20-6 <sup>11</sup> / <sub>16</sub>	28-4	21-1	29-0 <sup>11</sup> / <sub>16</sub>
5	21-1 <sup>1</sup> / <sub>2</sub>	28-9	21-8	29-5 <sup>13</sup> / <sub>16</sub>
6	21-9 <sup>5</sup> / <sub>8</sub>	29-3	22-4 <sup>5</sup> / <sub>16</sub>	30-0
7	22-6 <sup>7</sup> / <sub>8</sub>	29-10	23-1 <sup>7</sup> / <sub>8</sub>	30-7 <sup>1</sup> / <sub>8</sub>
8	23-5 <sup>1</sup> / <sub>4</sub>	30-5 <sup>7</sup> / <sub>8</sub>	24-0 <sup>7</sup> / <sub>16</sub>	31-3 <sup>1</sup> / <sub>4</sub>
9	24-4 <sup>1</sup> / <sub>2</sub>	31-2 <sup>9</sup> / <sub>16</sub>	25-0	32-0 <sup>3</sup> / <sub>16</sub>
10	25-4 <sup>5</sup> / <sub>8</sub>	32-0 <sup>1</sup> / <sub>8</sub>	26-0 <sup>7</sup> / <sub>16</sub>	32-9 <sup>15</sup> / <sub>16</sub>
11	26-5 <sup>7</sup> / <sub>16</sub>	32-10 <sup>3</sup> / <sub>8</sub>	27-1 <sup>9</sup> / <sub>16</sub>	33-8 <sup>1</sup> / <sub>2</sub>
12	27-6 <sup>15</sup> / <sub>16</sub>	33-9 <sup>5</sup> / <sub>16</sub>	28-3 <sup>7</sup> / <sub>16</sub>	34-7 <sup>11</sup> / <sub>16</sub>
	41 FEET		42 FEET	
1	20-6 <sup>7</sup> / <sub>8</sub>	29-0 <sup>1</sup> / <sub>2</sub>	21-0 <sup>7</sup> / <sub>8</sub>	29-9
2	20-9 <sup>3</sup> / <sub>8</sub>	29-2 <sup>5</sup> / <sub>16</sub>	21-3 <sup>1</sup> / <sub>2</sub>	29-10 <sup>7</sup> / <sub>8</sub>
3	21-1 <sup>9</sup> / <sub>16</sub>	29-5 <sup>5</sup> / <sub>16</sub>	21-7 <sup>3</sup> / <sub>4</sub>	30-1 <sup>15</sup> / <sub>16</sub>
4	21-7 <sup>5</sup> / <sub>16</sub>	29-9 <sup>7</sup> / <sub>16</sub>	22-1 <sup>5</sup> / <sub>8</sub>	30-6 <sup>1</sup> / <sub>8</sub>
5	22-2 <sup>1</sup> / <sub>2</sub>	30-2 <sup>11</sup> / <sub>16</sub>	22-9	30-11 <sup>1</sup> / <sub>2</sub>
6	22-11 <sup>11</sup> / <sub>16</sub>	30-9	23-5 <sup>3</sup> / <sub>4</sub>	31-6
7	23-8 <sup>13</sup> / <sub>16</sub>	31-4 <sup>5</sup> / <sub>16</sub>	24-3 <sup>3</sup> / <sub>4</sub>	32-11 <sup>2</sup> / <sub>2</sub>
8	24-7 <sup>5</sup> / <sub>8</sub>	32-0 <sup>5</sup> / <sub>8</sub>	25-2 <sup>7</sup> / <sub>8</sub>	32-10
9	25-7 <sup>1</sup> / <sub>2</sub>	32-9 <sup>13</sup> / <sub>16</sub>	26-3	33-7 <sup>3</sup> / <sub>8</sub>
10	26-8 <sup>1</sup> / <sub>4</sub>	33-7 <sup>13</sup> / <sub>16</sub>	27-4	34-5 <sup>5</sup> / <sub>8</sub>
11	27-9 <sup>11</sup> / <sub>16</sub>	34-6 <sup>9</sup> / <sub>16</sub>	28-5 <sup>7</sup> / <sub>8</sub>	35-4 <sup>11</sup> / <sub>16</sub>
12	28-11 <sup>7</sup> / <sub>8</sub>	35-6 <sup>1</sup> / <sub>16</sub>	29-8 <sup>3</sup> / <sub>8</sub>	36-4 <sup>1</sup> / <sub>2</sub>

**TABLE 1  
TABLES OF RAFTER LENGTHS**

RISE IN INCHES PER FOOT OF RUN	BUILDING WIDTH			
	43 FEET		44 FEET	
	COMMON FEET-INCHES	HIP-VAL FEET-INCHES	COMMON FEET-INCHES	HIP-VAL FEET-INCHES
1	21-6 <sup>7</sup> / <sub>8</sub>	30-5 <sup>1</sup> / <sub>2</sub>	22-0 <sup>15</sup> / <sub>16</sub>	31-2
2	21-9 <sup>9</sup> / <sub>16</sub>	30-7 <sup>3</sup> / <sub>8</sub>	22-3 <sup>5</sup> / <sub>8</sub>	31-3 <sup>15</sup> / <sub>16</sub>
3	22-1 <sup>15</sup> / <sub>16</sub>	30-10 <sup>1</sup> / <sub>2</sub>	22-8 <sup>1</sup> / <sub>8</sub>	31-7 <sup>1</sup> / <sub>8</sub>
4	22-7 <sup>15</sup> / <sub>16</sub>	31-2 <sup>7</sup> / <sub>8</sub>	23-2 <sup>1</sup> / <sub>4</sub>	31-11 <sup>9</sup> / <sub>16</sub>
5	23-3 <sup>1</sup> / <sub>2</sub>	31-8 <sup>3</sup> / <sub>8</sub>	23-10	32-5 <sup>1</sup> / <sub>4</sub>
6	24-0 <sup>7</sup> / <sub>16</sub>	32-3	24-7 <sup>3</sup> / <sub>16</sub>	33-0
7	24-10 <sup>11</sup> / <sub>16</sub>	32-10 <sup>11</sup> / <sub>16</sub>	25-5 <sup>5</sup> / <sub>8</sub>	33-7 <sup>7</sup> / <sub>8</sub>
8	25-10 <sup>1</sup> / <sub>16</sub>	33-7 <sup>3</sup> / <sub>8</sub>	26-5 <sup>5</sup> / <sub>16</sub>	34-4 <sup>3</sup> / <sub>4</sub>
9	26-10 <sup>1</sup> / <sub>2</sub>	34-5	27-6	35-2 <sup>5</sup> / <sub>8</sub>
10	27-11 <sup>13</sup> / <sub>16</sub>	35-3 <sup>1</sup> / <sub>2</sub>	28-7 <sup>5</sup> / <sub>8</sub>	36-1 <sup>3</sup> / <sub>8</sub>
11	29-2	36-2 <sup>13</sup> / <sub>16</sub>	29-10 <sup>1</sup> / <sub>8</sub>	37-0 <sup>15</sup> / <sub>16</sub>
12	30-4 <sup>7</sup> / <sub>8</sub>	37-2 <sup>7</sup> / <sub>8</sub>	31-1 <sup>3</sup> / <sub>8</sub>	38-1 <sup>1</sup> / <sub>4</sub>
	45 FEET		46 FEET	
1	22-6 <sup>15</sup> / <sub>16</sub>	31-10 <sup>1</sup> / <sub>2</sub>	23-0 <sup>15</sup> / <sub>16</sub>	32-7
2	22-9 <sup>3</sup> / <sub>4</sub>	32-0 <sup>1</sup> / <sub>2</sub>	23-3 <sup>13</sup> / <sub>16</sub>	32-9
3	23-2 <sup>5</sup> / <sub>16</sub>	32-3 <sup>3</sup> / <sub>4</sub>	23-8 <sup>1</sup> / <sub>2</sub>	33-0 <sup>3</sup> / <sub>8</sub>
4	23-8 <sup>5</sup> / <sub>8</sub>	32-8 <sup>5</sup> / <sub>16</sub>	24-2 <sup>15</sup> / <sub>16</sub>	33-5
5	24-4 <sup>1</sup> / <sub>2</sub>	33-2 <sup>1</sup> / <sub>16</sub>	24-11	33-10 <sup>15</sup> / <sub>16</sub>
6	25-1 <sup>7</sup> / <sub>8</sub>	33-9	25-8 <sup>9</sup> / <sub>16</sub>	34-6
7	26-0 <sup>9</sup> / <sub>16</sub>	34-5 <sup>1</sup> / <sub>16</sub>	26-7 <sup>1</sup> / <sub>2</sub>	35-2 <sup>1</sup> / <sub>4</sub>
8	27-0 <sup>1</sup> / <sub>2</sub>	35-2 <sup>1</sup> / <sub>8</sub>	27-7 <sup>11</sup> / <sub>16</sub>	35-11 <sup>1</sup> / <sub>2</sub>
9	28-1 <sup>1</sup> / <sub>2</sub>	36-0 <sup>3</sup> / <sub>16</sub>	28-9	36-9 <sup>13</sup> / <sub>16</sub>
10	29-3 <sup>7</sup> / <sub>16</sub>	36-11 <sup>3</sup> / <sub>16</sub>	29-11 <sup>1</sup> / <sub>4</sub>	37-9 <sup>1</sup> / <sub>16</sub>
11	30-6 <sup>1</sup> / <sub>4</sub>	37-11 <sup>1</sup> / <sub>16</sub>	31-2 <sup>7</sup> / <sub>16</sub>	38-9 <sup>1</sup> / <sub>8</sub>
12	31-9 <sup>13</sup> / <sub>16</sub>	38-11 <sup>5</sup> / <sub>8</sub>	32-6 <sup>5</sup> / <sub>16</sub>	39-10 <sup>1</sup> / <sub>16</sub>



**TABLE 1  
TABLES OF RAFTER LENGTHS**

RISE IN INCHES PER FOOT OF RUN	BUILDING WIDTH			
	47 FEET		48 FEET	
	COMMON FEET-INCHES	HIP-VAL FEET-INCHES	COMMON FEET-INCHES	HIP-VAL FEET-INCHES
1	23-7	33-3 <sup>1</sup> / <sub>2</sub>	24-1	34-0
2	23-9 <sup>7</sup> / <sub>8</sub>	33-5 <sup>9</sup> / <sub>16</sub>	24-4	34-2 <sup>1</sup> / <sub>8</sub>
3	24-2 <sup>11</sup> / <sub>16</sub>	33-9	24-8 <sup>7</sup> / <sub>8</sub>	34-5 <sup>5</sup> / <sub>8</sub>
4	24-9 <sup>1</sup> / <sub>4</sub>	34-1 <sup>3</sup> / <sub>4</sub>	25-3 <sup>9</sup> / <sub>16</sub>	34-10 <sup>7</sup> / <sub>16</sub>
5	25-5 <sup>1</sup> / <sub>2</sub>	34-7 <sup>3</sup> / <sub>4</sub>	26-0	35-4 <sup>5</sup> / <sub>8</sub>
6	26-3 <sup>5</sup> / <sub>16</sub>	35-3	26-10	36-0
7	27-2 <sup>1</sup> / <sub>2</sub>	35-11 <sup>3</sup> / <sub>8</sub>	27-9 <sup>7</sup> / <sub>16</sub>	36-8 <sup>9</sup> / <sub>16</sub>
8	28-2 <sup>15</sup> / <sub>16</sub>	36-8 <sup>7</sup> / <sub>8</sub>	28-10 <sup>1</sup> / <sub>8</sub>	37-6 <sup>1</sup> / <sub>4</sub>
9	29-4 <sup>1</sup> / <sub>2</sub>	37-7 <sup>7</sup> / <sub>16</sub>	30-0	38-5
10	30-7 <sup>1</sup> / <sub>16</sub>	38-6 <sup>7</sup> / <sub>8</sub>	31-2 <sup>7</sup> / <sub>8</sub>	39-4 <sup>3</sup> / <sub>4</sub>
11	31-10 <sup>9</sup> / <sub>16</sub>	39-7 <sup>1</sup> / <sub>4</sub>	32-6 <sup>11</sup> / <sub>16</sub>	40-5 <sup>3</sup> / <sub>8</sub>
12	33-2 <sup>13</sup> / <sub>16</sub>	40-8 <sup>7</sup> / <sub>16</sub>	33-11 <sup>5</sup> / <sub>16</sub>	41-6 <sup>13</sup> / <sub>16</sub>
	49 FEET		50 FEET	
1	24-7	34-8 <sup>1</sup> / <sub>2</sub>	25-1 <sup>1</sup> / <sub>16</sub>	35-5
2	24-10 <sup>1</sup> / <sub>16</sub>	34-10 <sup>11</sup> / <sub>16</sub>	25-4 <sup>1</sup> / <sub>8</sub>	35-7 <sup>3</sup> / <sub>16</sub>
3	25-3 <sup>1</sup> / <sub>16</sub>	35-2 <sup>1</sup> / <sub>4</sub>	25-9 <sup>1</sup> / <sub>4</sub>	35-10 <sup>13</sup> / <sub>16</sub>
4	25-9 <sup>7</sup> / <sub>8</sub>	35-7 <sup>3</sup> / <sub>16</sub>	26-4 <sup>1</sup> / <sub>4</sub>	36-3 <sup>7</sup> / <sub>8</sub>
5	26-6 <sup>1</sup> / <sub>2</sub>	36-1 <sup>7</sup> / <sub>16</sub>	27-1	36-10 <sup>5</sup> / <sub>16</sub>
6	27-4 <sup>11</sup> / <sub>16</sub>	36-9	27-11 <sup>7</sup> / <sub>16</sub>	37-6
7	28-4 <sup>3</sup> / <sub>8</sub>	37-5 <sup>3</sup> / <sub>4</sub>	28-11 <sup>5</sup> / <sub>16</sub>	38-2 <sup>15</sup> / <sub>16</sub>
8	29-5 <sup>3</sup> / <sub>8</sub>	38-3 <sup>11</sup> / <sub>16</sub>	30-0 <sup>9</sup> / <sub>16</sub>	39-1 <sup>1</sup> / <sub>16</sub>
9	30-7 <sup>1</sup> / <sub>2</sub>	39-2 <sup>5</sup> / <sub>8</sub>	31-3	40-0 <sup>1</sup> / <sub>4</sub>
10	31-10 <sup>11</sup> / <sub>16</sub>	41-2 <sup>5</sup> / <sub>8</sub>	32-6 <sup>1</sup> / <sub>2</sub>	41-0 <sup>7</sup> / <sub>16</sub>
11	33-2 <sup>13</sup> / <sub>16</sub>	41-3 <sup>1</sup> / <sub>2</sub>	33-11	42-1 <sup>5</sup> / <sub>8</sub>
12	34-7 <sup>3</sup> / <sub>4</sub>	42-5 <sup>1</sup> / <sub>4</sub>	35-4 <sup>1</sup> / <sub>4</sub>	43-3 <sup>5</sup> / <sub>8</sub>

**TABLE 2**  
**Difference in Length of Jack Rafters**

<b>FOR VARIOUS SPACING</b>				
<b>Rise</b>	<b>(FEET-INCHES)</b>			
	<b>16"</b>	<b>18"</b>	<b>20"</b>	<b>24"</b>
1	1-4 <sup>1</sup> / <sub>16</sub>	1-6 <sup>1</sup> / <sub>16</sub>	1-8 <sup>1</sup> / <sub>16</sub>	2-0 <sup>1</sup> / <sub>16</sub>
2	1-4 <sup>1</sup> / <sub>4</sub>	1-6 <sup>1</sup> / <sub>4</sub>	1-8 <sup>1</sup> / <sub>4</sub>	2-0 <sup>5</sup> / <sub>16</sub>
3	1-4 <sup>1</sup> / <sub>2</sub>	1-6 <sup>9</sup> / <sub>16</sub>	1-8 <sup>5</sup> / <sub>8</sub>	2-0 <sup>3</sup> / <sub>4</sub>
4	1-4 <sup>7</sup> / <sub>8</sub>	1-7	1-9 <sup>1</sup> / <sub>16</sub>	2-1 <sup>5</sup> / <sub>16</sub>
5	1-5 <sup>5</sup> / <sub>16</sub>	1-7 <sup>1</sup> / <sub>2</sub>	1-9 <sup>11</sup> / <sub>16</sub>	2-2
6	1-5 <sup>7</sup> / <sub>8</sub>	1-8 <sup>1</sup> / <sub>8</sub>	1-10 <sup>3</sup> / <sub>8</sub>	2-2 <sup>13</sup> / <sub>16</sub>
7	1-6 <sup>1</sup> / <sub>2</sub>	1-8 <sup>13</sup> / <sub>16</sub>	1-11 <sup>1</sup> / <sub>8</sub>	2-3 <sup>13</sup> / <sub>16</sub>
8	1-7 <sup>1</sup> / <sub>4</sub>	1-9 <sup>5</sup> / <sub>8</sub>	2-0 <sup>1</sup> / <sub>16</sub>	2-4 <sup>7</sup> / <sub>8</sub>
9	1-8	1-10 <sup>1</sup> / <sub>2</sub>	2-1	2-6
10	1-8 <sup>13</sup> / <sub>16</sub>	1-11 <sup>7</sup> / <sub>16</sub>	2-2 <sup>1</sup> / <sub>16</sub>	2-7 <sup>1</sup> / <sub>4</sub>
11	1-9 <sup>11</sup> / <sub>16</sub>	2-0 <sup>7</sup> / <sub>16</sub>	2-3 <sup>1</sup> / <sub>8</sub>	2-8 <sup>9</sup> / <sub>16</sub>
12	1-10 <sup>5</sup> / <sub>8</sub>	2-1 <sup>7</sup> / <sub>16</sub>	2-4 <sup>5</sup> / <sub>16</sub>	2-9 <sup>15</sup> / <sub>16</sub>
13	1-11 <sup>9</sup> / <sub>16</sub>	2-2 <sup>9</sup> / <sub>16</sub>	2-5 <sup>1</sup> / <sub>2</sub>	2-11 <sup>3</sup> / <sub>8</sub>
14	2-0 <sup>9</sup> / <sub>16</sub>	2-3 <sup>11</sup> / <sub>16</sub>	2-6 <sup>3</sup> / <sub>4</sub>	3-0 <sup>7</sup> / <sub>8</sub>
15	2-1 <sup>5</sup> / <sub>8</sub>	2-4 <sup>13</sup> / <sub>16</sub>	2-8	3-2 <sup>7</sup> / <sub>16</sub>
16	2-2 <sup>11</sup> / <sub>16</sub>	2-6	2-9 <sup>5</sup> / <sub>16</sub>	3-4
17	2-3 <sup>3</sup> / <sub>4</sub>	2-7 <sup>3</sup> / <sub>16</sub>	2-10 <sup>11</sup> / <sub>16</sub>	3-5 <sup>5</sup> / <sub>8</sub>
18	2-4 <sup>7</sup> / <sub>8</sub>	2-8 <sup>7</sup> / <sub>16</sub>	3-0 <sup>1</sup> / <sub>16</sub>	3-7 <sup>1</sup> / <sub>4</sub>
19	2-5 <sup>15</sup> / <sub>16</sub>	2-9 <sup>11</sup> / <sub>16</sub>	3-1 <sup>7</sup> / <sub>16</sub>	3-8 <sup>15</sup> / <sub>16</sub>
20	2-7 <sup>1</sup> / <sub>8</sub>	2-11	3-2 <sup>7</sup> / <sub>8</sub>	3-10 <sup>5</sup> / <sub>8</sub>
21	2-8 <sup>1</sup> / <sub>4</sub>	3-0 <sup>1</sup> / <sub>4</sub>	3-4 <sup>5</sup> / <sub>16</sub>	4-0 <sup>3</sup> / <sub>8</sub>
22	2-9 <sup>7</sup> / <sub>16</sub>	3-1 <sup>9</sup> / <sub>16</sub>	3-5 <sup>3</sup> / <sub>4</sub>	4-2 <sup>1</sup> / <sub>8</sub>
23	2-10 <sup>9</sup> / <sub>16</sub>	3-2 <sup>15</sup> / <sub>16</sub>	3-7 <sup>1</sup> / <sub>4</sub>	4-3 <sup>7</sup> / <sub>8</sub>
24	2-11 <sup>3</sup> / <sub>4</sub>	3-4 <sup>1</sup> / <sub>4</sub>	4-8 <sup>3</sup> / <sub>4</sub>	4-5 <sup>11</sup> / <sub>16</sub>

---

**Rafter Lengths-** For building widths in feet and inches:

The following tables are used to determine rafter lengths (common, hip and valley) for building widths which are in feet and fractions of a foot.

For example, to find the length of a common rafter for a 34 foot, 7 inch wide building with a roof rise of 8 inches per foot of run, find the length of a common rafter for a 34 foot wide building as 20 feet,  $5^{3/16}$  inches from the previous tables. From the following table 3, find the additional length to add for 7 inch width and 8 inch rise as  $4^{3/16}$  inches. Add this to the 20 feet,  $5^{3/16}$  inches and obtain 20 feet,  $9^{3/8}$  inches as the correct common rafter length.

To determine the lengths of hip and valley rafters, proceed as above using the appropriate preceding tables and table 4.

---

TABLE 3

<b>ADDITIONAL LENGTH IN INCHES TO ADD TO COMMON RAFTERS</b>						
Rise	For Inches Additional Building Width					
	<b>1</b>	<b>2</b>	<b>3</b>	<b>4</b>	<b>5</b>	<b>6</b>
1	1/2	1	1 1/2	2	2 9/16	3 1/16
2	1/2	1	1 1/2	2	2 9/16	3 1/16
3	1/2	1	1 9/16	2 1/16	2 9/16	3 1/16
4	1/2	1 1/16	1 9/16	2 1/8	2 5/8	3 3/16
5	9/16	1 1/16	1 5/8	2 3/16	2 11/15	3 1/4
6	9/16	1 1/8	1 1/16	2 1/4	2 13/16	3 3/8
7	9/16	1 3/16	1 3/4	2 5/16	2 7/8	3 1/2
8	5/8	1 3/16	1 13/16	2 3/8	3	3 5/8
9	5/8	1 1/4	1 7/8	2 1/2	3 1/8	3 3/4
10	5/8	1 5/16	1 15/16	2 5/8	3 1/4	3 7/8
11	11/16	1 3/8	2 1/16	2 11/16	3 3/8	4 1/16
12	11/16	1 7/16	2 1/8	2 13/16	3 9/16	4 1/4
13	3/4	1 1/2	2 3/16	2 15/16	3 11/16	4 7/16
14	3/4	1 9/16	2 1/4	3 1/16	3 13/16	4 5/8
15	13/16	1 5/8	2 3/8	3 3/16	4	4 13/16
16	13/16	1 11/16	2 1/2	3 5/16	4 3/16	5
17	7/8	1 3/4	2 5/8	3 7/16	4 5/16	5 3/16
18	7/8	1 13/16	2 11/16	3 5/8	4 1/2	5 7/16
19	15/16	1 7/8	2 13/16	3 3/4	4 11/16	5 5/8
20	1	1 15/16	2 15/16	3 7/8	4 7/8	5 13/16
21	1	2	3	4 1/16	5 1/16	6 1/16
22	1 1/16	2 1/16	3 1/8	4 3/16	5 1/4	6 1/4
23	1 1/16	2 3/16	3 1/4	4 5/16	5 3/8	5 7/16
24	1 1/8	2 1/4	3 3/8	4 1/2	5 9/16	6 11/16

TABLE 3

<b>ADDITIONAL LENGTH IN INCHES TO ADD TO COMMON RAFTERS</b>					
Rise	For Inches Additional Building Width				
	<b>7</b>	<b>8</b>	<b>9</b>	<b>10</b>	<b>11</b>
1	39/16	41/16	49/16	51/16	59/16
2	39/16	41/16	49/16	51/16	59/16
3	35/8	41/8	45/8	51/8	511/16
4	311/16	43/16	43/4	51/4	513/16
5	313/16	45/16	47/8	57/16	515/16
6	315/16	41/2	51/16	59/16	61/8
7	41/16	45/8	53/16	513/16	63/8
8	43/16	413/16	57/16	6	65/8
9	43/8	5	55/8	61/4	67/8
10	49/16	53/16	57/8	61/2	73/16
11	43/4	57/16	61/8	613/16	77/16
12	415/16	511/16	63/8	71/16	73/4
13	53/16	57/8	65/8	73/8	81/8
14	53/8	61/8	615/16	711/16	87/16
15	55/8	63/8	73/16	8	813/16
16	513/16	611/16	71/2	85/16	93/16
17	61/16	715/16	713/16	811/16	99/16
18	65/16	73/16	81/8	9	915/16
19	69/16	71/2	87/16	93/8	105/16
20	613/16	73/4	83/4	911/16	1011/16
21	71/16	81/16	91/16	101/16	111/16
22	75/16	83/8	93/8	107/16	111/2
23	79/16	85/8	93/4	1013/16	117/8
24	713/16	815/16	101/16	113/16	125/16

TABLE 4

<b>ADDITIONAL LENGTH IN INCHES TO ADD TO HIP &amp; VALLEY RAFTER</b>						
Rise	For Inches Additional Building Width					
	<b>1</b>	<b>2</b>	<b>3</b>	<b>4</b>	<b>5</b>	<b>6</b>
1	11/16	17/16	21/8	213/16	39/16	41/4
2	11/16	17/16	21/8	27/8	39/16	41/4
3	11/16	17/16	21/8	27/8	39/16	45/16
4	3/4	17/16	23/16	215/16	35/8	43/8
5	3/4	11/2	23/16	215/16	311/16	47/16
6	3/4	11/2	21/4	3	33/4	41/2
7	3/4	11/2	29/16	31/16	313/16	49/16
8	13/16	19/16	23/8	31/8	315/16	411/16
9	13/16	15/8	23/8	33/16	4	413/16
10	13/16	15/8	27/16	35/16	41/8	415/16
11	13/16	111/16	21/2	33/8	43/16	51/16
12	7/8	13/4	25/8	37/16	45/16	53/16
13	7/8	113/16	211/16	39/16	47/16	53/8
14	15/16	113/16	23/4	311/16	49/16	51/2
15	15/16	17/8	213/16	33/4	43/4	511/16
16	15/16	115/16	27/8	37/8	413/16	513/16
17	1	2	3	4	5	6
18	1	21/16	31/16	41/8	51/8	63/16
19	11/16	21/8	33/16	41/4	55/16	63/8
20	11/16	23/16	31/4	43/8	57/16	39/16
21	11/8	21/4	33/8	41/2	55/8	63/4
22	13/16	25/16	31/2	45/8	513/16	615/16
23	13/16	23/8	39/16	43/4	6	71/8
24	11/4	21/2	311/16	47/8	61/8	73/8

TABLE 4

<b>ADDITIONAL LENGTH IN INCHES TO ADD TO HIP &amp; VALLEY RAFTER</b>					
Rise	For Inches Additional Building Width				
	<b>7</b>	<b>8</b>	<b>9</b>	<b>10</b>	<b>11</b>
1	4 <sup>15</sup> / <sub>16</sub>	5 <sup>11</sup> / <sub>16</sub>	6 <sup>3</sup> / <sub>8</sub>	7 <sup>1</sup> / <sub>16</sub>	7 <sup>13</sup> / <sub>16</sub>
2	5	5 <sup>11</sup> / <sub>16</sub>	6 <sup>7</sup> / <sub>16</sub>	7 <sup>1</sup> / <sub>8</sub>	7 <sup>13</sup> / <sub>16</sub>
3	5	5 <sup>3</sup> / <sub>4</sub>	6 <sup>7</sup> / <sub>16</sub>	7 <sup>3</sup> / <sub>16</sub>	7 <sup>7</sup> / <sub>8</sub>
4	5 <sup>1</sup> / <sub>16</sub>	5 <sup>13</sup> / <sub>16</sub>	6 <sup>9</sup> / <sub>16</sub>	7 <sup>1</sup> / <sub>4</sub>	8
5	5 <sup>3</sup> / <sub>16</sub>	5 <sup>7</sup> / <sub>8</sub>	6 <sup>5</sup> / <sub>8</sub>	7 <sup>3</sup> / <sub>8</sub>	8 <sup>1</sup> / <sub>8</sub>
6	5 <sup>1</sup> / <sub>4</sub>	6	6 <sup>3</sup> / <sub>4</sub>	7 <sup>1</sup> / <sub>2</sub>	8 <sup>1</sup> / <sub>4</sub>
7	5 <sup>3</sup> / <sub>8</sub>	6 <sup>1</sup> / <sub>8</sub>	6 <sup>7</sup> / <sub>8</sub>	7 <sup>5</sup> / <sub>8</sub>	8 <sup>7</sup> / <sub>16</sub>
8	5 <sup>1</sup> / <sub>2</sub>	6 <sup>1</sup> / <sub>4</sub>	7 <sup>1</sup> / <sub>16</sub>	7 <sup>13</sup> / <sub>16</sub>	8 <sup>5</sup> / <sub>8</sub>
9	5 <sup>5</sup> / <sub>8</sub>	6 <sup>3</sup> / <sub>8</sub>	7 <sup>3</sup> / <sub>16</sub>	8	8 <sup>13</sup> / <sub>16</sub>
10	5 <sup>3</sup> / <sub>4</sub>	6 <sup>9</sup> / <sub>16</sub>	7 <sup>3</sup> / <sub>8</sub>	8 <sup>3</sup> / <sub>16</sub>	9
11	5 <sup>7</sup> / <sub>8</sub>	6 <sup>3</sup> / <sub>4</sub>	7 <sup>9</sup> / <sub>16</sub>	8 <sup>7</sup> / <sub>16</sub>	9 <sup>1</sup> / <sub>4</sub>
12	6 <sup>1</sup> / <sub>16</sub>	6 <sup>15</sup> / <sub>16</sub>	7 <sup>13</sup> / <sub>16</sub>	8 <sup>11</sup> / <sub>16</sub>	9 <sup>1</sup> / <sub>2</sub>
13	6 <sup>1</sup> / <sub>4</sub>	7 <sup>1</sup> / <sub>8</sub>	8	8 <sup>15</sup> / <sub>16</sub>	9 <sup>13</sup> / <sub>16</sub>
14	6 <sup>7</sup> / <sub>16</sub>	7 <sup>5</sup> / <sub>16</sub>	8 <sup>1</sup> / <sub>4</sub>	9 <sup>3</sup> / <sub>16</sub>	10 <sup>1</sup> / <sub>16</sub>
15	6 <sup>5</sup> / <sub>8</sub>	7 <sup>9</sup> / <sub>16</sub>	8 <sup>1</sup> / <sub>2</sub>	9 <sup>7</sup> / <sub>16</sub>	10 <sup>3</sup> / <sub>8</sub>
16	6 <sup>3</sup> / <sub>4</sub>	7 <sup>3</sup> / <sub>4</sub>	8 <sup>11</sup> / <sub>16</sub>	9 <sup>11</sup> / <sub>16</sub>	10 <sup>5</sup> / <sub>8</sub>
17	7	8	9	10	11
18	7 <sup>3</sup> / <sub>16</sub>	8 <sup>1</sup> / <sub>4</sub>	9 <sup>1</sup> / <sub>4</sub>	10 <sup>5</sup> / <sub>16</sub>	11 <sup>5</sup> / <sub>16</sub>
19	7 <sup>7</sup> / <sub>16</sub>	8 <sup>1</sup> / <sub>2</sub>	9 <sup>9</sup> / <sub>16</sub>	10 <sup>5</sup> / <sub>8</sub>	11 <sup>11</sup> / <sub>16</sub>
20	7 <sup>5</sup> / <sub>8</sub>	8 <sup>3</sup> / <sub>4</sub>	9 <sup>13</sup> / <sub>16</sub>	10 <sup>15</sup> / <sub>16</sub>	12
21	7 <sup>7</sup> / <sub>8</sub>	9	10 <sup>1</sup> / <sub>8</sub>	11 <sup>1</sup> / <sub>4</sub>	12 <sup>3</sup> / <sub>8</sub>
22	8 <sup>1</sup> / <sub>8</sub>	9 <sup>1</sup> / <sub>4</sub>	10 <sup>7</sup> / <sub>16</sub>	11 <sup>9</sup> / <sub>16</sub>	12 <sup>3</sup> / <sub>4</sub>
23	8 <sup>5</sup> / <sub>16</sub>	9 <sup>1</sup> / <sub>2</sub>	10 <sup>11</sup> / <sub>16</sub>	11 <sup>11</sup> / <sub>16</sub>	13 <sup>1</sup> / <sub>8</sub>
24	8 <sup>9</sup> / <sub>16</sub>	9 <sup>13</sup> / <sub>16</sub>	11	12 <sup>1</sup> / <sub>4</sub>	13 <sup>1</sup> / <sub>2</sub>

