

STANLEY

DOWELING JIG

No. 59

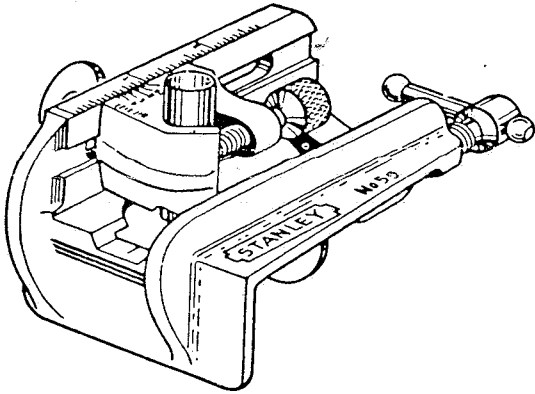

The Stanley Doweling Jig is an essential tool for all woodworkers. It facilitates boring dowel holes in the edge, end or surface of work. It is also an excellent bit guide for mortising.

In using the Doweling Jig, there is no guesswork—no need of truing the bit with a try square—simply clamp the Jig to the work at the right position, bring the Guide to a proper graduation mark, and the bit will be guided straight at right angles to the work, resulting in properly aligned holes for making doweled joints.

Depth gauge and six guides— $3/16$, $1/4$, $5/16$, $3/8$, $7/16$ and $1/2$ inch—are furnished with each Doweling Jig. Guides for $9/16$, $5/8$ and $3/4$ inch bits are available as accessories.

The Doweling Jig can be clamped on stock up to $2-7/8$ inches thick.

Six guides are furnished with Stanley Doweling Jig—to bore holes for $3/16$, $1/4$, $5/16$, $3/8$, $7/16$ and $1/2$ inch dowels.

Twist bits for wood or machine wood bits or twist drills for metal may be used. These are made with the twists parallel so they provide quite accurate guidance through the guides. Such bits selected to fit snugly in the guides will produce almost perfect results. The holes may be slightly large for the dowels but probably only enough to provide room for glue. It is customary to saw a slight kerf the length of each dowel pin to avoid having glue locked in the bottom of hole. Unless this is done, your dowel joint may not fit tight, or it may split the wood when clamps are applied, caused by the glue that cannot escape in the bottom of the holes.

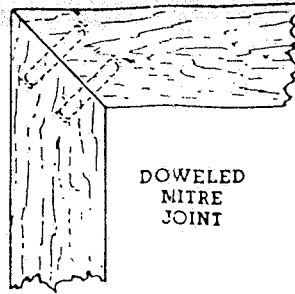

DOWELED MITRE JOINT

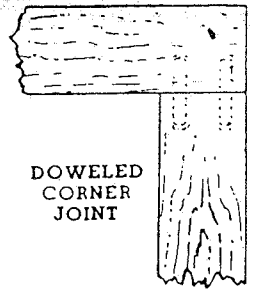

DOWELED CORNER JOINT

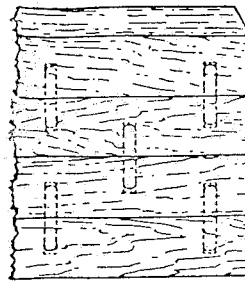

DOWELED STOCK

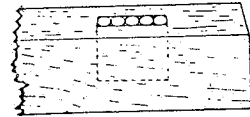

MORTISING

Directions for Use

1.

Indicate on face side of work a center line for any number of dowels desired

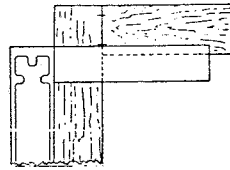

2.

Select a suitable size dowel for your wood and the same size guide. Secure the guide bevel end up, in slide with bottom of guide practically flush with under side of the guide.

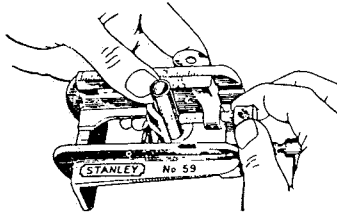

3.

Adjust the slide, aligning the index line for the guide selected at the proper graduation to bring the center of the hole the distance desired from the face side of the wood. An index line is given on the slide for each guide or bit size.

Example: For a $3/8$ " guide, adjust the slide to bring the index line No. 6 to the desired graduation mark. If the dowel is to be in the center of a 1" piece of wood adjust the slide to the $1/2$ " graduation mark and fasten securely with thumb screw.

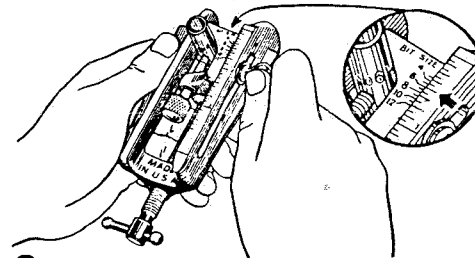

4.

Place the Jig on one of the pieces of stock with the fence next to the face side of the wood and bring the center line "A" in alignment with the mark on the wood, illustrated in No. 1. Clamp the Jig securely.

Recently the plate on the clamping screw was improved by making it a rectangular shape. It has two staggered holes provided for screw so a small piece of wood may be attached to eliminate any marring of the work

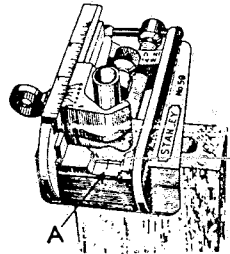

5.

Place the bit of proper size into the guide using care not to strike the cutting edges of the bit against the guide. Bore for each hole to desired depth, using depth gauge clamped on bit.

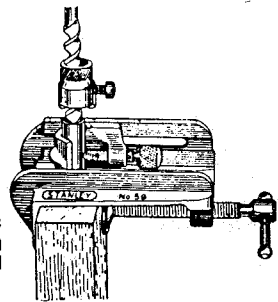

6.

Place dowels in hole and complete the joint

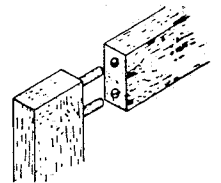

STANLEY helps you do things right

STANLEY TOOLS, Division of The Stanley Works, New Britain, Conn. 06050