



SQUARES

TABLES, CHARTS AND
GENERAL INFORMATION

STANLEY

THE STEEL SQUARE

	Page
INTRODUCTION	2
CHAPTER 1 - THE STEEL SQUARE	3-6
Description of Square - Graduations - Tables and Scales	
CHAPTER 2 - ROOF FRAMING	6-16
Types of Roofs - Definition of Span, Run, Rise, Pitch - Definition of Plate and Ridge Board - Types of Rafters - Top, Bottom and Side Cuts - Measuring Line, Length, Tail and Length per foot run	
CHAPTER 3 - COMMON RAFTERS	16-23
Definition of Length - Top and Bottom Cuts - Actual Length - Applying the Square	
CHAPTER 4 - HIP AND VALLEY RAFTERS	24-31
Description - Length of Hip and Valley Rafters - Top and Bottom Cuts - Side Cuts	
CHAPTER 5 - JACK RAFTERS	31-34
Description - Length of Jack Rafters - Top and Bottom Cuts - Side Cuts	
CHAPTER 6 - BRACE MEASURE	34-35
CHAPTER 7 - ESSEX BOARD MEASURE	35-36
CHAPTER 8 - EIGHT SQUARE SCALE	36-37
POLYGONS AND THEIR MITERS	38-39
LAYING OUT A STAIR	40-41
RAFTER TABLES	42-93

©1991 The Stanley Works



WORK SAFELY WITH TOOLS BY WEARING SAFETY GOGGLES

INTRODUCTION

Among all the tools used by the carpenter there is, perhaps, none so useful, simple and indispensable as the modern Steel Square. There is not a tool that may be so readily applied to the quick solution of the many difficult problems of laying out work as the Steel Square. In the hands of one who knows how to use it the square becomes a simple calculating device of the most wonderful capacity.

The understanding of a very few simple rules governing the application of this Square will enable the carpenter to easily and quickly determine the length of Common, Hip, Valley or Jack Rafters for any Pitch of Roof, and to make the proper Top and Bottom Cuts as well as Side or Cheek Cuts for any Rafter.

The Steel Square herein illustrated is typical of rafter squares made by *Stanley Tools, New Britain, Conn.* These squares may be relied upon as being as near perfect as it is possible to make them.

The great variety of markings on the Body and Tongue of the many styles of Stanley Steel Squares cover almost everything that these instruments are capable of and make them adaptable for almost any purpose the carpenter may require.

Superior quality of material, supreme workmanship, accuracy of graduations and completeness of Reference Tables make Stanley rafter squares the best instruments for framing purposes on the market today.

At the rear of this book are comprehensive tables of rafter lengths of Common, Hip and Valley rafters for buildings from one to fifty feet in width.

1. THE SQUARE

The Steel Square is made in the form of a right angle, that is its two arms (the body and the tongue) make an angle of 90 degrees, which is a right angle

By referring to the diagram in Fig 1, it will be noted that if we connect points "A" and "C" by drawing a straight line we will have a triangle "ABC," and since the angle "B" on the Square is a right angle - the triangle will be a "right-triangle." Therefore the Steel Square as well as all roof framing is based on the principles of a right triangle

A right triangle is a figure having three sides Base, Altitude and Hypotenuse. The hypotenuse is the longest side of the triangle and is always opposite the right angle. Fig 2

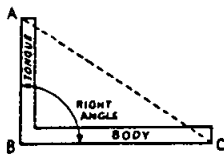

STEEL SQUARE

FIG. 1

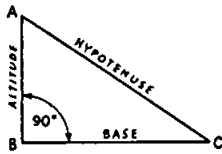

RIGHT TRIANGLE

FIG. 2

The reference tables on the *Stanley Squares* and in this book were carefully prepared in accordance with the above mentioned principles

The following terms identifying the different portions of the Steel Square should be noted and remembered

The Steel Square consists of two parts the Body or Blade and the Tongue Figs 3 and 4

1 BODY The Body is the longer and wider part The Body of the Stanley Standard Steel Square is 24 inches long and 2 inches wide

2 TONGUE The Tongue is the shorter and narrower part and usually is 16 inches long and 1½ inches wide

3 HEEL The point at which the body and tongue meet on the outside edge of the Square is called the Heel The intersection of the inner edges of the body and tongue is sometimes also called the Heel

4 FACE The Face of the Square is the side on which the name "Stanley" is stamped, or the visible side, while holding the body in the left hand and tongue in the right hand Fig 3

5 BACK The Back is the side opposite to the face Fig 4

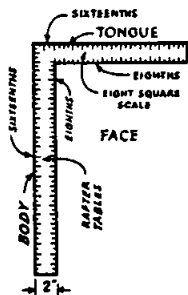

FIG 3

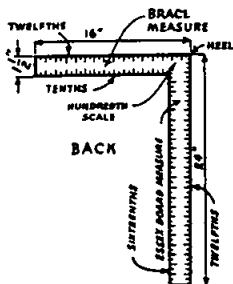

FIG 4

The modern Square usually has two kinds of markings Scales and Tables

6 SCALES The Scales are the inch divisions found on the outer and inner edges of the Square and the inches graduated into fractions of an inch

7 RAFTER TABLES These tables will be found on the face of the body of rafter squares and will help you to determine rapidly the lengths of rafters as well as their cuts

The rafter tables consist of six lines of figures and their use is indicated on the left end of the body

The first line of figures gives the lengths of Common rafters per foot run

The second line gives the lengths of Hip and Valley Rafters per foot run

The third line gives the length of the first Jack Rafter and the differences in the length of the others centered at 16 inches

The fourth line gives the length of the first Jack Rafter and the differences in length of the others spaced at 24 inch centers

The fifth line gives the side cuts of Jacks

The sixth line gives the side cuts of Hip and Valley Rafters

8 OCTAGON SCALE The Octagon or "eight square" scale is found along the center of the face of the tongue. By the use of this scale a square timber may be shaped into one having eight sides or an "octagon."

9 BRACE MEASURE This table is found along the center of the back of the tongue and gives the exact lengths of Common Braces.

10 ESSEX BOARD MEASURE This table is on the back of the body and gives the contents of any size timber.

A detailed description of all scales and tables accompanied with complete directions how to use them will be found on the following pages.

2. ROOF FRAMING

There are numerous types of roofs and a great variety of shapes. The following are the most common in use.

11 SHED OR LEAN-TO ROOF This is the simplest type of a roof and has only a single slope. Fig. 6.

12 GABLE OR PITCH ROOF This is a type of roof most commonly used. It has two slopes meeting at the center or ridge and forming a Gable. It is a very simple form of a roof and, perhaps, the easiest to construct. Fig. 7.

13 HIP ROOF This roof consists of four sides, all sloping toward the center of the building. The

rafters run up diagonally to meet the ridge, into which the other rafters are framed Fig 8

14 GABLE AND VALLEY OR HIP AND VALLEY ROOF This is a combination of two Gable or Hip roofs intersecting each other. The Valley is the place of meeting of two slopes of the roof, running in different directions. There is a great variety of modifications of this roof and the intersections usually are at right angles Figs 9 and 10

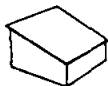

LEAN-TO ROOF

FIG 6

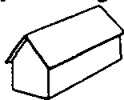

GABLE ROOF

FIG 7

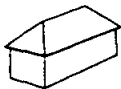

HIP ROOF

FIG 8

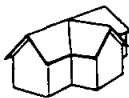

GABLE AND VALLEY ROOF

FIG 9

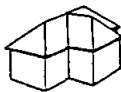

HIP AND VALLEY ROOF

FIG 10

The following definitions relate to the various roof members and terms used in roof framing

15 SPAN The Span of a roof is the distance over the wall plates, also called the width of the building

16 RUN The Run of a roof is the shortest horizontal distance measured from a plumb line through the center of the ridge to the outer edge of the plate

In equally-pitched roofs the Run is always equal to half of the span or generally half the width of the building

17 RISE The rise of a roof is the distance from the top of the ridge and of the rafter to the level of the foot. In figuring rafters the rise is considered as the vertical distance from the top of the wall plate to the upper end of the measuring line.

Rule To find the rise of a roof multiply the pitch by the span.

Example A building is 16 feet wide and has a roof $\frac{1}{4}$ pitch. What is the rise?
Rise equals $\frac{1}{4} \times 16 = 4$ feet

The span, run, rise, pitch and measuring line are illustrated in Fig. 11.

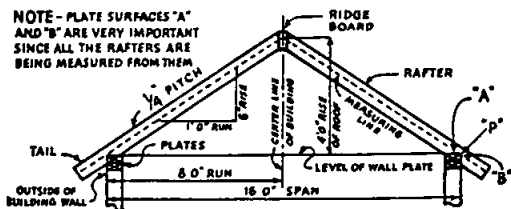

SPAN, RUN, RISE and PITCH

FIG. 11

18 DECK ROOF When rafters rise to a deck instead of a ridge the width of the deck should be subtracted from the span and the remainder divided by two will equal the run. Thus in Fig. 12 the span equals 32 feet and the deck is 12 feet wide. The difference between 32 and 12 is 20 feet, divided by 2 equals 10 feet, which is the run of the common rafters. Since the rise equals 10 feet, it is a $\frac{1}{2}$ Pitch roof.

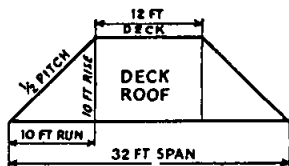

FIG 12

19 PITCH The Pitch of a roof is the slant or the slope from the ridge to the plate and it may be expressed in several ways

- A The Pitch may be described in terms of the ratio of the total rise of the roof to the total width of the building. Thus the Pitch of a roof having a 24 ft span with an 8 ft rise - will be 8 divided by 24 equals $\frac{1}{3}$ Pitch Fig 13
- B The Pitch of a roof may also be expressed as so many inches of vertical rise to each foot of horizontal run. A roof with 24 ft span and rising 8 inches to each foot of run will have a total rise of $8 \times 12 = 96$ inches or 8 ft. 8 divided by 24 equals $\frac{1}{3}$. Therefore the roof is $\frac{1}{3}$ Pitch Fig 13

Rule To find the pitch of a roof divide the rise by the span

Example A building is 24 ft wide and has a roof with 6 ft rise. What is the pitch of the roof? Fig 14

Pitch equals 6 divided by 24 equals $\frac{1}{4}$

20 PRINCIPAL PITCHES The diagram in Fig 15 shows the principal Roof Pitches They are called 1/2 pitch, 1/3 pitch, as the case may be, because the height from the level of the wall plate to the ridge of the roof is one half, one third, or one quarter of the total width of the building

It will be noted that roofs of the same widths may have different pitches depending upon the height of the roof

Reference to the Roof Frame in Fig 16 (page 11) will materially assist in the interpretation of the various terms commonly used in roof construction

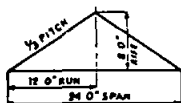

THIRD PITCH
FIG. 13

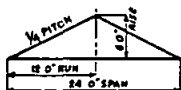

FOURTH PITCH
FIG. 14

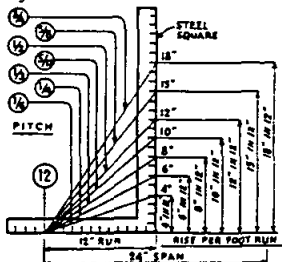

PRINCIPAL ROOF PITCHES
FIG. 15

21 The principal members of the roof frame are the Plates at the bottom and the Ridge Board at the top To them the various rafters are being fastened

22 PLATE The plate is the roof member to which rafters are framed at their lower ends

The top "A" and the outside edge of the plate "B" are the important surfaces from which rafters are measured Fig 11

23 RIDGE BOARD The Ridge Board is the horizontal member used for connecting the upper ends of rafters on one side to the rafters on the opposite side

In cheap construction the ridge board is usually omitted and the upper ends of the rafters are spiked together

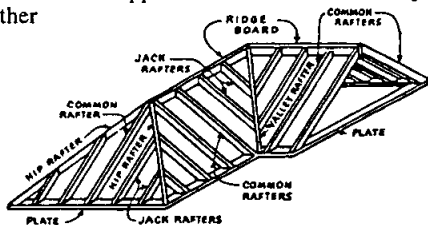

ROOF FRAME

FIG 16

24 COMMON RAFTERS A common Rafter is a roof member extending diagonally from the plate to the ridge

25 HIP RAFTERS A Hip Rafter is a member extending diagonally from the corner of the plate to the ridge

26 VALLEY RAFTERS A Valley Rafter is one extending diagonally from plate to ridge at the line of intersection of two roof surfaces

27 JACK RAFTERS Any rafter that does not extend from plate to ridge is called a Jack Rafter

There are different kinds of Jacks and according to the position they occupy they may be classified as

- A Hip Jacks,
- B Valley Jacks, and
- C Cripple Jacks

A Jack Rafter with the upper end resting against a hip and lower end against the plate is called a Hip Jack

A Jack with the upper end resting against the ridge board and lower end against the valley is called a Valley Jack

A Jack that is cut in between a hip and valley rafter is called a Cripple Jack A Cripple Jack touches neither the plate nor the ridge

All Rafters must be cut to proper angles so that they will fit at the points where they are framed

28 TOP OR PLUMB CUT The cut of the rafter end which rests against the ridge board or against the opposite rafter is called the Top or Plumb Cut

29 BOTTOM OR HEEL CUT The cut of the rafter end that rests against the plate is called the Bottom or Heel Cut The bottom cut is also called the Foot or Seat Cut

30 SIDE CUTS Hip and Valley Rafters as well as all Jacks besides having top and bottom cuts must also have their sides at the end cut to a proper bevel so that they will fit into the other members to which they are to be framed These are called Side Cuts or Cheek Cuts All rafters and their cuts are indicated in Fig 17

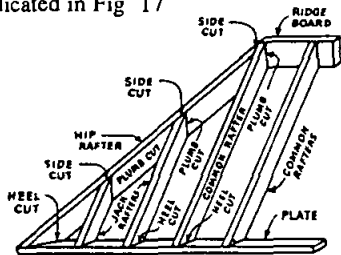

RAFTER CUTS

FIG 17

31 **MEASURING LINE** This is a temporary line on which the length of the rafter is measured. This line runs parallel to the edge of the rafter and passes through the point "P" on the outer edge of the plate which is the point from which all dimensions are determined Fig 11, Page 14

32 **LENGTH** The length of a rafter is the shortest distance between the outer edge of the plate and the center of the ridge line

33 **TAIL** That portion of the rafter extending beyond the outside edge of the plate is called the Tail or Eave. The Tail is figured separately and is not included in the "length" of the rafter Fig 11, Page 8

34 **LENGTH PER FOOT RUN** The rafter tables on the *Stanley Squares* are based on the "rise per foot run" which means that the figures in the tables indicate the length of rafters "per one foot run" of common rafters for any rise of roof. This principle is clearly illustrated in Fig 18

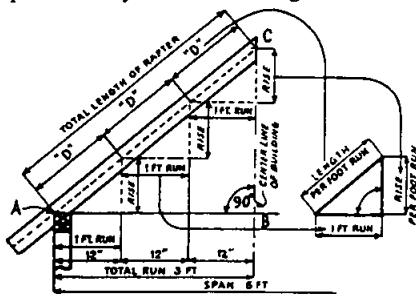

LENGTH PER FOOT RUN

FIG 18

The roof has a 6 foot span and a certain rise per foot. The figure may be regarded as a right triangle "ABC" having for its sides the run, rise and the rafter.

The run of the rafter has been divided into three equal parts each representing "one foot run."

It will be noted that by drawing vertical lines through each division point of the run the rafter also will be divided into three equal parts "D."

Since each part "D" represents "the length of rafter per one foot run" and the total run of the rafter equals three feet, it is evident that the "total length" of rafter will equal the "length D" multiplied by 3.

The reason for using this "per foot run" method is that the length of any rafter may be easily determined for any width of building. The length per foot run will be different for different pitches, therefore before you can establish the length of a rafter you must know the rise of roof in inches or the "rise per foot run."

Rule To find the rise per foot run, multiply the rise by 12 and divide by the length of run.

The factor 12 is to obtain a value in inches, the rise and run being expressed in feet. Figs. 19 and 20.

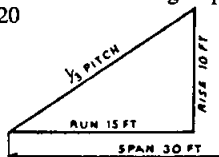

$$\text{Rise} = 10 \text{ Ft.}$$

$$\text{Run} = 15 \text{ Ft.}$$

$$\text{Pitch} = 10 - 30 = \frac{1}{3}$$

$$\text{Rise Per Foot Run} = \frac{10 \times 12}{15} = 8''$$

FIG 19

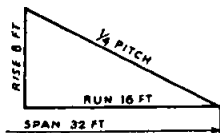

$$\text{Rise} = 8 \text{ Ft.}$$

$$\text{Run} = 16 \text{ Ft.}$$

$$\text{Pitch} = 8 - 32 = \frac{1}{4}$$

$$\text{Rise Per Foot Run} = \frac{8 \times 12}{16} = 6''$$

FIG 20

The rise per foot run is always the same for a given pitch and can be easily remembered for all ordinary pitches, thus

PITCH	1/2	1/3	1/4	1/6
Rise per foot run in inches	12	8	6	4

35 The members of a firmly constructed roof should fit snugly against each other. Rafters that are not properly cut make a shaky roof and impair the stability of the structure. Therefore it is very essential that all rafters should be of correct lengths and their ends properly cut so as to provide a full bearing against the members to which they are connected.

Correct length, proper top and bottom cuts and the right side or cheek cuts are the very important features to be observed when framing a roof.

The length of rafters may be obtained in several ways, among them

- 1 Use of Rafter Tables on the *Stanley Square*
- 2 Use of Tables of Calculated Lengths
- 3 Mathematical Calculations
- 4 Stepping off with the square

The first method utilizes the rafter tables on the *Stanley Steel Square*, which allows the carpenter to determine rafter lengths and cuts for the most common pitches without the need for reference tables.

The second method is accurate for those pitches and building widths for which the tables are published. A comprehensive set of tables is found in the rear of this book.

Mathematical calculations are most easily done with a calculator, utilizing formulas for rafter lengths but are somewhat tedious.

Stepping off with the square allows the determination of rafter lengths without any figuring, but the repeated moving of the square demands care to avoid accumulating any errors.

This book discusses the method utilizing the table found on the Stanley Square and the method utilizing the comprehensive tables found in this book.

3. COMMON RAFTERS

36 DEFINITION OF LENGTH A common Rafter extends from the plate to the ridge. Therefore it is evident that the rise, run and the rafter itself form a "right triangle."

The length of a Common Rafter is the shortest distance between the outer edge of the plate and a point on the center line of the ridge. This length is taken along the "measuring line" which runs parallel to the edge of the rafter and is the "hypotenuse" or the longest side of a right triangle, the other two sides being the run and the rise. Fig 21

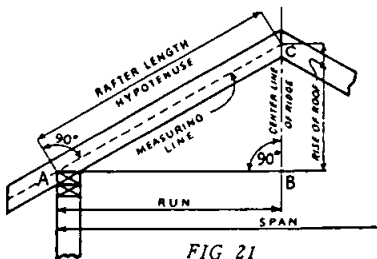

The Rafter Tables on the face of the body include the outside edge graduations on both body and tongue which are in inches and sixteenths of an inch

37 LENGTH OF RAFTERS The lengths of Common Rafters are found on the "first" line indicated as Length of main rafters per foot run. There are seventeen of these tables beginning at 2 inches and continuing to 18 inches Fig 22

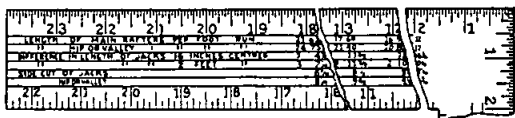

Rule To find the length of a common rafter, multiply the "length given in the table" by the number of feet of the run

Example Find the length of a common rafter where the rise of roof is 8 inches per foot run or one third pitch and building is 20 feet wide First find on the "inch line" on the top edge of the body the figure that is equal to the rise of the roof which in this case will be 8 On the first line under the figure 8 will be found 14 42 which is the length of the rafter in inches "per foot run" for this particular pitch Fig 23

The building is 20 feet wide
Therefore the run of the rafter will be
 $20 \div 2 = 10$ feet

Since the length of the rafter per "one foot run" equals 14 42 inches, the total length of rafter will be 14 42 multiplied by 10 which equals 144 20 inches or $144 \div 12 = 12$ feet or for practical purposes 12 feet
Fig 24

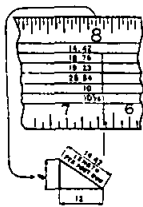

FIG 23

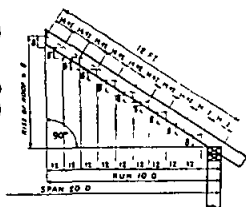

FIG 24

38 TOP AND BOTTOM CUTS The top or plumb cut is the cut at the upper end of the rafter where it rests against the opposite rafter or against the ridge board

The bottom or heel cut is the cut at the lower end which rests on the plate

The top cut is parallel to the center line of the roof, the bottom cut is parallel to the horizontal plane of the plates Therefore the top and bottom cuts are at right angles to each other

Rule To obtain the top and bottom cuts of a common rafter use 12 inches on the body and the "rise per foot run" on the tongue 12 inches on the body will give the horizontal cut and the figure on the tongue the vertical cut

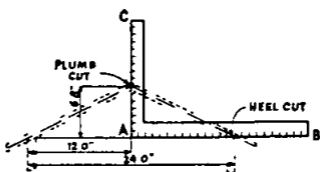
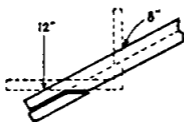
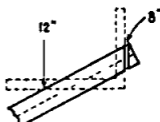

FIG 25



HEEL CUT

FIG 26



PLUMB CUT

FIG 27

To illustrate we will imagine a large square placed alongside the rafter as shown in Fig 25 We may notice that the edge of the tongue coincides with the top cut of the rafter and the edge of the

blade coincides with the heel cut. If this square were marked in feet it would show the run of the rafter on the body and the total rise on the tongue. The line "AB" would give us the bottom cut and line "AC" the top cut.

However, the regular square is marked in inches and since the relation of the rise to one foot run is the same as the total rise bears to the total run, we use 12 inches on the blade, and the "rise per foot" on the tongue to obtain the respective cuts. The distance "12" is used as a unit and is the "one foot run" while the figure on the other arm of the square represents the "rise" per foot run. Figs 26 and 27.

39 ACTUAL LENGTH The lengths of rafters obtained from the tables are "to the center line of the ridge." Therefore the thickness of half of the ridge board should always be deducted from the obtained total length before the top cut is made. Fig 28. This deduction of half the thickness of the ridge is measured at right angles to the Plumb line and is marked parallel to this line.

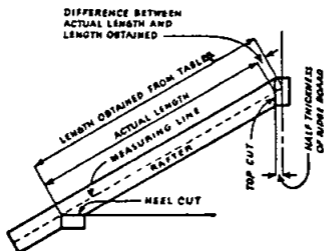
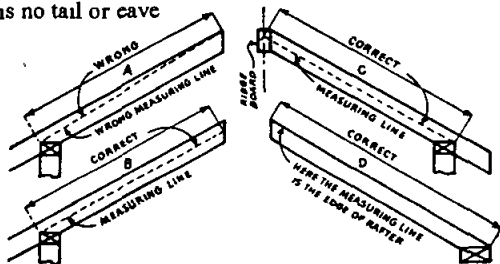

FIG 28—ACTUAL LENGTH

40 The diagrams below illustrate the wrong and right way of measuring the length of rafters Fig 29. The diagram "D" shows the measuring line as the edge of the rafter which is the case when there is no tail or cave



MEASURING LINES

FIG 29

41 **APPLYING THE SQUARE** After the total length of the rafter has been established both ends should be marked and allowance made for a tail or eave, and for half the thickness of the ridge

Both cuts are obtained by applying the Square so that the 12 inch mark on the body and the mark on the tongue that represents the rise shall be at the edge of the stock

All cuts for common rafters are made at right angles to the side of the rafter

Example A common rafter is 12 ft 6 inches, the rise per foot run being 9 inches Obtain the top and bottom cuts Fig 30

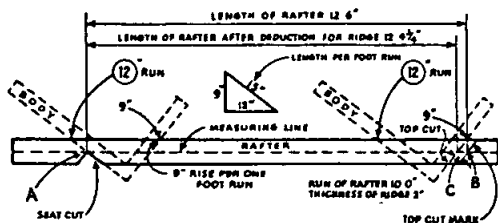

APPLYING THE SQUARE

FIG 30

Points "A" and "B" are the ends of the rafter. To obtain the bottom or seat cut take 12 inches on the body of the square and 9 inches on the tongue. Lay the square on the rafter so that the body will coincide with point "A" or the lower end of the rafter. Mark along the body of the square and cut.

To obtain the top cut move the square so that the tongue coincides with point "B" which is the upper end of the rafter. Mark along the tongue of the square.

42 DEDUCTION FOR RIDGE The deduction for half the thickness of the ridge should now be measured. Half the thickness of the ridge is 1 inch. One inch is deducted at right angles to the top cut mark or plumb line, point "C". A line is then drawn parallel to the top cut mark and the cut made. You will notice that the allowance for half the ridge measured along the measuring line is $1\frac{1}{4}$ inches. This will vary according to the rise per foot run. It is therefore important to measure for this deduction at right angles to the top cut mark or plumb line.

43 MEASURING RAFTERS The length of rafters having a tail or eave can also be measured along the back or top edge instead of the measuring line as illustrated below. To do this it is necessary to carry a plumb line to the top edge from P and the measurement started from this point.

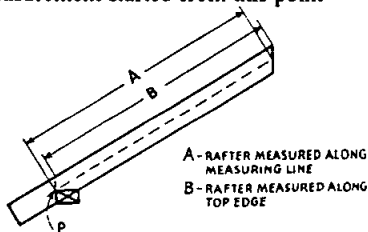

FIG 30A

44 ODD INCHES OF COMMON RAFTERS Occasionally in framing a roof the run may have an odd number of inches as in the case of a building with a span of 24 feet 10 inches. This would mean a run of 12 feet 5 inches. The additional five inches can be easily added without mathematical division after the figures obtained from the square for 12 feet of run are measured. The additional five inches are measured at right angles to the last plumb line as illustrated in Fig (30B)

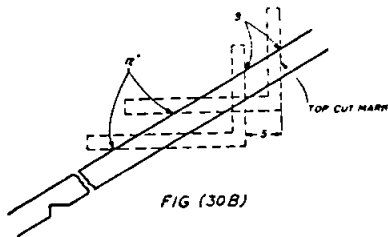
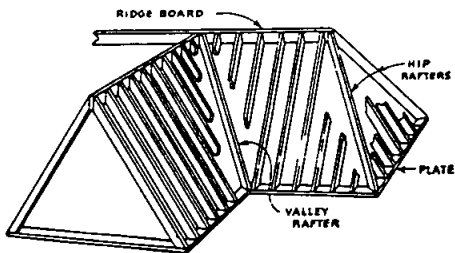

FIG (30B)

4. HIP AND VALLEY RAFTERS

45 The Hip Rafter is a roof member that forms a "hip" in the roof usually extending from the corner of the building diagonally to the ridge

The Valley Rafter is similar to the hip only that it forms a "valley" or depression in the roof instead of a hip It also extends diagonally from plate to ridge Therefore the total rise of hip and valley rafters is the same as that of common rafters Fig 31



HIP AND VALLEY RAFTERS

FIG. 31

The relation of hip and valley rafters to common rafters is the same as the relation of the sides of a right triangle, therefore it will be well to explain here one of the main features of right triangles

In a right triangle if the sides forming the "right angle" are 12 inches each the hypotenuse or the side opposite the right angle is equal to 16.97 inches which is usually taken as "17" inches Fig 32

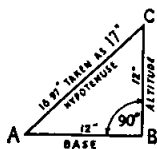
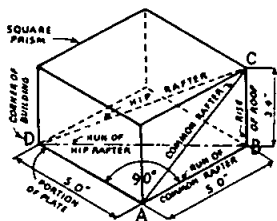

FIG 32



RELATIVE POSITION

FIG 33

46 The position of the hip rafter and its relation to the common rafter is plainly illustrated in Figs 33 and 35 where the hip rafter is compared to the "diagonal" of a square prism

The prism has a base of 5 feet square and its height is 3 feet 4 inches

- "D" is the corner of the building,
- "BC" is the total rise of the roof,
- "AB" is the run of the common rafter,
- "AC" is the common rafter,
- "DB" is the run of the hip rafter,
- "DC" is the hip rafter

It will be noted that the figure "DAB" is a right triangle whose sides are the portion of the plate - "DA," the run of common rafter - "AB" and the run of hip rafter - "DB" The run of the hip rafter being opposite the right angle "A" is the "hypotenuse" or the longest side of the right triangle

If we should take only one foot of run of common rafter and one foot length of plate we will have a right triangle "H" whose sides are each 12 inches long and whose hypotenuse is 17 inches or more accurately 16.97 inches Fig 35

The hypotenuse in this small triangle "H" is a portion of the run of the hip rafter "DB" which corresponds to one foot run of common rafter

Therefor the "run of hip rafter" is always 16 97 inches for every 12 inches of foot run of common rafter, and the "total run" of hip rafter/will be 16 97 inches multiplied by the number of feet run of common rafter

47 LENGTH OF HIP AND VALLEY RAFTERS. The lengths of hip and valley rafters are found on the "second" line of the rafter table entitled "Length of hip or valley rafters per foot run," which means that the figures in the table indicate the length of hip and valley rafters "per foot run of common rafters " Fig 22

Rule To find the length of a hip or valley rafter - multiply the length given in the table by the number of feet of the run of common rafter

Example Find the length of a hip rafter where the rise of roof is 8 inches per foot run or one third pitch and building is 10 feet wide Fig 35

Proceed the same as in the case of common rafters, i e , find on the "inch line" of the body of the square the figure corresponding to the rise of roof - which is 8 On the "second" line under this figure is found "18 76" which is the length of hip rafter in inches for each foot of run of common rafter for one third pitch Fig 34

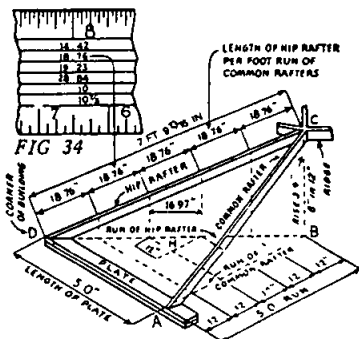

FIG 35

The common rafter has a 5 foot run and therefore there are also 5 equal lengths for the hip rafter as may be seen in the illustration Fig 35

We have found the length of the hip rafter to be 18 76 inches per one foot run Therefore the total length of hip rafter will be $18\ 76 \times 5 = 93\ 80$ inches = 7 81 feet or for practical purposes 7 feet 9 13/16

48 TOP AND BOTTOM CUTS The following rule should be followed for top and bottom cuts

Rule To obtain the top and bottom cuts of hip or valley rafters use 17 inches on the body and the "rise per foot run" on the tongue 17 on the body will give the seat cut and the figure on the tongue the vertical or top cut Fig 36

49 MEASURING HIP AND VALLEY RAFTERS The length of all hip and valley rafters must always be measured along the center of the top edge or back. The rafters with a tail or eave are treated similarly to common rafters as mentioned in paragraph No 44 and illustrated in Fig 30A, page 22, except the measurement or measuring line is the center of the top edge

50 DEDUCTION FROM HIP OR VALLEY RAFTER FOR RIDGE The deduction for the ridge is measured the same as for the common rafter, Fig 30, page 23, except that half the diagonal (45°) thickness of the ridge must be used

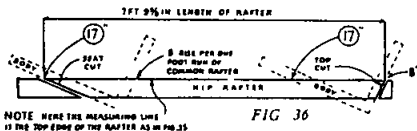

51 SIDE CUTS Hip and valley rafters in addition to the top and bottom cuts must also have side or cheek cuts at the point where they meet the ridge

These side cuts are found on the "sixth" or bottom line of the Rafter tables which is marked "Side cut hip or valley - use "

The figures given in this line refer to the graduation marks on the "outside edge of the body " Fig 22

The figures on the square have been derived by determining the figure to be used with 12 on the tongue for the side cuts of the various pitches by the following method

From a plumb line the thickness of the rafter is measured and marked at right angles as at A, Fig 36A. A line is then squared across the top of the rafter and the diagonal points connected as at B. The line B or side cut is obtained by marking along the tongue of the square.

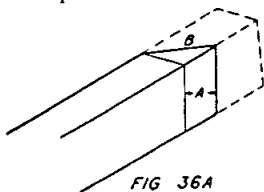

Rule To obtain the side cut for hip or valley rafters - take the figure given in the table - on the body of the square and 12 inches on the tongue. Mark side cut along the tongue where the tongue coincides with the point on the measuring line.

Example Find side cut for hip rafter - the roof having 8 inches rise per foot run or one third pitch. Figs 37 and 38

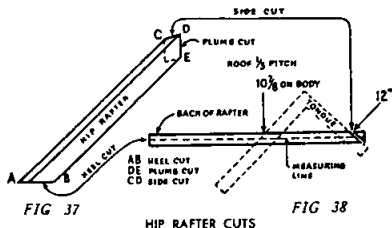

Figure 37 represents the position of the hip rafter on the roof. The rise of roof

being 8 inches to the foot, first locate the figure 8 on the outside edge of the body Under this figure in the bottom line you find "10 $\frac{7}{8}$ " This figure is taken on the body and 12 inches on the tongue The square is applied to the edge of the back of the hip rafter The side cut "CD" comes along the tongue

The deduction for half the thickness of the ridge must be determined and measured the same as for the common rafters, Fig 30, page 22, except that half the diagonal (45°) thickness of the ridge must be used

In making the seat cut for the hip rafter an allowance must be made for the top edges of the rafter which would project above the line of the common and jack rafters if the corners of the hip rafter were not removed or "backed" The hip rafter must be slightly lowered by cutting parallel to the seat cut a distance which varies with the thickness and pitch of the roof

52 It should be noted that on the Stanley Square the 12 inch mark on the tongue is always used in all angle cuts, both top, bottom and side, thus leaving the workman but one number to remember when laying out side or angle cuts, namely the figure taken from the fifth or sixth line in the table

The side cuts come always on the "right hand" or "tongue" side on rafters When marking

boards, these can be reserved for convenience at any time by taking the 12 inch mark on the body and using the body references on the tongue

53 ODD INCHES OF HIP AND VALLEY RAFTERS For obtaining additional inches in run of hip or valley rafters similar to the explanation for common rafters, No 45, page 28 - Fig (30B), the diagonal (45°) of the additional inches or approximately $7 \frac{1}{16}$ inches for five inches of run should be used in a similar manner

5. JACK RAFTERS

54 Jack rafters are "discontinued" common rafters - or common rafters "cut off" by the intersection of a hip or valley before reaching the full length from plate to ridge

Jack rafters lie in the same plane with common rafters They usually are spaced the same and have the same pitch and therefore they also have the same length per foot run as common rafters have

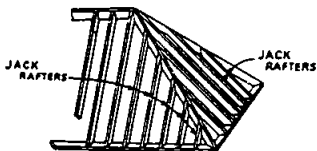

FIG 39

Jack rafters are usually spaced 16 inches or 24 inches apart and as they rest against the hip or valley equally spaced the second jack must be twice as long as the first one, the third three times as long as the first and so on Fig 39

55. LENGTH OF JACK RAFTERS The lengths of jacks are given in the third and fourth line of the rafter tables and are indicated

3rd line "Difference in length of Jacks - 16 inches centers "

4th line "Difference in length of Jacks - 2 feet centers "

The figures in the table indicate the "length of the first or shortest Jack" which is also the difference in length between the first and second, between the second and third jack and so on

Rule To find the length of a jack rafter, multiply the value given in the tables by the number indicating the position of the jack. From the obtained length subtract half the diagonal (45°) thickness of the hip or valley rafter

Example Find the length of the second jack rafter, the roof having a rise of 8 inches to 1 foot of run of common rafter, the spacing of jacks being 16 inches

On the outer edge of the body find figure 8 which corresponds to the rise of roof. On the third line under this figure, find 19 1/4 inches long. This means that the first jack rafter will be 19 1/4 inches long. Since the length of the second jack is required, multiply 19 1/4 by 2 which equals 38 1/2 inches. From this length half, the diagonal (45°) thickness of the hip or valley rafter should be deducted in the same manner as the

deduction was made on the hip rafter for the ridge

Proceed in the same manner when the lengths of jacks spaced 24 inch centers are required. It should be borne in mind that the second jack is twice as long as the first one, the third jack is three times as long as the first jack and so on.

56 TOP AND BOTTOM CUTS Since jack rafters have the same "rise per foot run" as common rafters, the method of obtaining the top and bottom cuts is the same as for common rafters, i.e., take 12 inches on the body and the rise per foot run on the tongue. 12 inches will give the seat cut and the figure on the tongue - the plumb cut.

57 SIDE CUT At the end where the jack rafter frames to the hip or valley rafter a side cut is required.

The side cuts for jacks are found on the "fifth line" of the Rafter tables and which is marked "Side cut of jacks - use", Fig. 22.

Rule To obtain the side cut for a jack rafter - take the figure shown in the table - on the body of the square and 12 inches on the tongue. Mark along the tongue for side cut.

Example Find side cut for jack rafters - of a roof having 8 inch rise per foot run or 1/3 pitch. Figs. 40 and 41.

Under figure 8 in the fifth line of the table find "10". This figure taken on the

outside edge of the body - and 12 inches on the tongue will give the required side cut

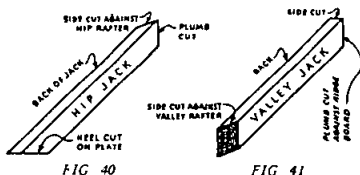

6. BRACE MEASURE

58 This table will be found along the center of the back of the tongue and gives the lengths of common braces Fig 42

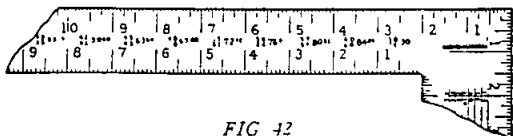

FIG 42

Example Find the length of a brace whose run on post and beam equals 39 inches Fig 43 In the Brace table find the following expression

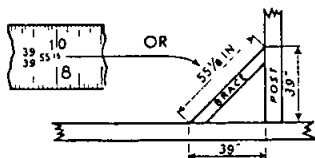

FIG 43

Which means that with a 39 inch run on the beam and a 39 inch run on the post the length of the brace will be 55 15 inches, or for practical purposes 55 1/8"

Braces may be regarded as common rafters. Therefore when the brace run on the post differs from the run on the beam - their lengths as well as top and bottom cuts may be determined from the figures given in the tables of common rafters

7. ESSEX BOARD MEASURE

59 This table appears on the back of the body, and gives the contents in Board Measure of almost any size of board or timber

The Inch graduations along the outer edge of the square are used in combination with the values given along the seven parallel lines

The figure "12" on the outer edge represents a "one-inch board - 12 inches wide," and is the starting point for all calculations. All the inch graduations on both sides of "12" represent the width and the smaller figures in the column under 12 indicate the length of the piece

The figures in the vertical columns under the inch graduations denote the board measure. Fig 44

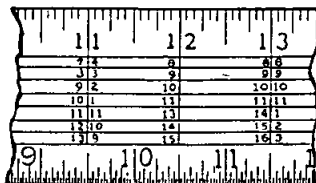

FIG 44

Rule To find the contents of a piece of lumber Under the mark 12 on the outer edge of the square find the "length" of the piece Along the same scale of inch graduations locate the "width" of the timber Then follow the line on which the length is stamped toward the column of figures under the given width The figure given at the point of intersection indicates the board measure of the piece

Example Find the board measure of a board 8 feet long and 11 inches wide
First find 8 feet in the column under "12" for the length in feet, then find 11 inches on the top edge of the square for the width in inches follow the lines to where they come together and 7-4 or seven and four twelfths is found to be the number on feet in the board

The figures in the tables are given for boards "one inch" thick To obtain the contents for any other thickness multiply the figure given in the table by the thickness of the timber

8. EIGHT SQUARE SCALE

60 This scale is along the center of the face of the tongue and is used for laying off lines to cut an "eight-square" or octagon piece of timber from a square one Fig 45

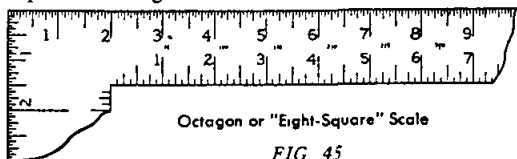

FIG 45

Example Required to shape an octagon out of a square timber "ABCD" 8 inches square Through the center of the timber draw lines "AB" and "CD" parallel to the sides and at right angles to each other With dividers take as many spaces from the scale as there are inches in the width of the stick - 8 and lay off this space on both sides of points A, B, C and D, as Aa, Ab, Bf, Be, Ch, Cg, Dc, and Dd Draw lines ah, bc, de and fg and cut off solid triangles 1, 2, 3 and 4 This will make an octagon or an "eight square " Fig 46

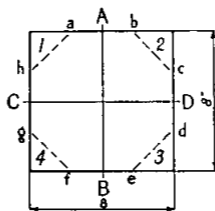

FIG 46

**LENGTH OF SIDES
WITH A
CIRCUMSCRIBED
DIAMETER OF 1 FT**

Sides	Length
3 Sides	10 3923 in
4 "	8 4953 "
5 "	7 0534 "
6 "	6 0000 "
7 "	5 2070 "
8 "	4 5921 "
9 "	4 1042 "
10 "	3 7032 "
11 "	3 3813 "
12 "	3 1058 "
14 "	2 6688 "
16 "	2 3410 "
18 "	2 0888 "

**LENGTH OF SIDES
WITH AN
INSCRIBED
DIAMETER OF 1 FT**

Sides	Length
3 Sides	20 7840 in
4 "	12 0000 "
5 "	8 7184 "
6 "	6 9282 "
7 "	5 7795 "
8 "	4 9705 "
9 "	4 3576 "
10 "	3 8990 "
11 "	3 5230 "
12 "	3 2154 "
14 "	2 7373 "
16 "	2 3869 "
18 "	2 1159 "

POLYGONS AND THEIR MITERS

USE FIGURES ON SQUARE

TONGUE	BLADE	TONGUE	BLADE
3 Sides	12 in	20 7/8 in	
4 "	12 "	12 "	
5 "	12 "	8 25/32 "	
6 "	12 "	6 15/16 "	
7 "	12 "	5 25/32 "	
8 "	12 "	4 31/32 "	
9 "	12 "	4 3/8 "	
10 Sides	12 in	3 7/8 in	
11 "	12 "	3 17/32 "	
12 "	12 "	3 7/32 "	
14 "	12 "	2 3/4 "	
16 "	12 "	2 13/32 "	
18 "	12 "	2 1/8 "	
20 "	12 "	1 29/32 "	

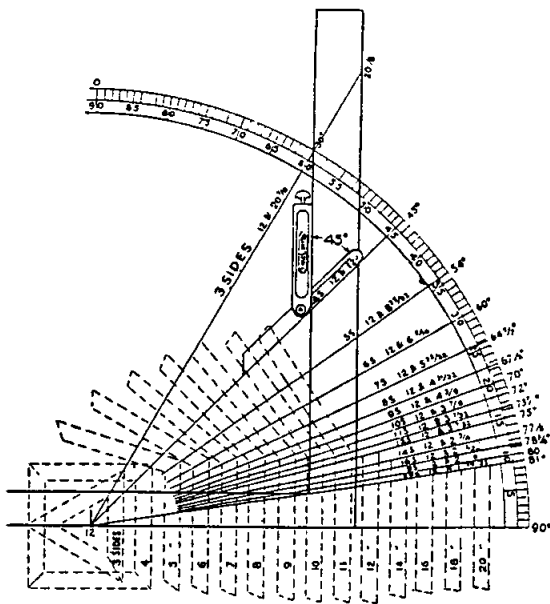

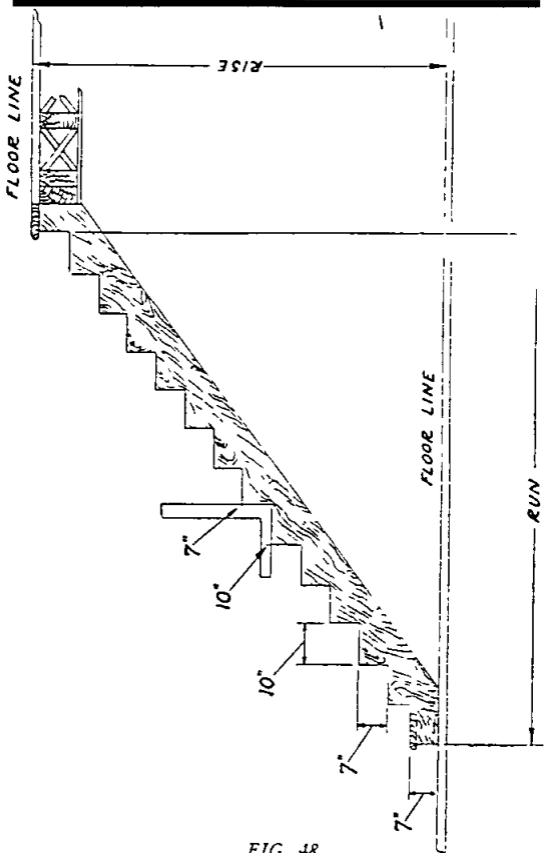

FIG 48

NOTE The stairs shown with approximately the above dimensions of the riser and tread are considered easy or comfortable to climb

LAYING OUT A STAIR

Books have been written about the great many applications of the Square for framing trusses, towers, circles, polygon shaped structures, etc , which we cannot include in these few pages

Public libraries are apt to have several volumes for the person who wants to study the wide range of uses of the Steel Square Stair building alone has many ramifications

In the following we offer just the fundamentals for laying out a straight stair

First Determine the height or Rise from the top of the floor from which the stairs start, to the top of the floor on which they are to end

Second Determine the Run or distance measured horizontally

Third Mark the total Rise on a rod or a piece of furring 1" x 2" to make a so-called "story pole " Divide the height or Rise into the number of risers desired A simple method is to lay out the number of risers wanted by spacing off the total Rise with a pair of compasses It is common to have this result in fractions of an inch

Example Total Rise 8' - 3 3/4 or 99 3/4" divided by fourteen = 7 125" or 7 1/8" riser

The above procedure is not necessary in the next step because the horizontal distance, or Run, is seldom limited to an exact space as is the case of the Rise

Fourth Lay out or space off the number of treads wanted in the horizontal distance or Run There is always one less tread than there are risers If there are 14 risers in the stair there are only 13 treads

Example If the tread is 10" wide and the riser is 7", the stair stringer would be layed out or so called "stepped off" with the square, ready for cutting as shown in Fig 48

The thickness of the tread should be deducted from the first riser as shown, in order to have this first step of uniform height with all the others



**LENGTH
OF
COMMON,
HIP/VALLEY
AND
JACK RAFTERS
FOR BUILDINGS
1 TO 50 FEET IN WIDTH
WITH RISE FROM
1/2 INCH PER FOOT
TO 24 INCHES PER FOOT**

NOTES ON USE OF THE TABLES

1. When the building is not an even number of feet such as 24' 5 1/2", find the common or hip/valley rafter length for 24' and for 5 1/2" and add them together to determine the correct length of rafter.

2. Plumb and seat cut angles are indicated by the square when it is placed upon the rafter with one leg at the inchmark under "Plumb" and the other leg at the inchmark under "Seat".

3. For side cuts of hip/Valley and jack rafters, determine the plumb cut, mark a second line on the side of the rafter equal to the thickness of the rafter, and square both lines across the top of the rafter. Connecting these lines diagonally across the top of the rafter determines the side cut.

RISE = .5 INCHES PER FOOT

BLDG WIDTH FEET	COMMON RAFTER FT INCHES	HIP/VALLEY RAFTER FT INCHES	ADD'L WIDTH INCHES	ADD'L COMMON LENGTH	ADDED HIP/VAL LENGTH
1	0 6	0 8 7/16	0 1/2	0 1/4	0 3/8
2	1 0	1 5	1	0 1/2	0 11/16
3	1 6	2 1 7/16	1 1/2	0 3/4	1 1/16
4	2 0	2 9 15/16	2	1	1 7/16
5	2 6	3 6 7/16	2 1/2	1 1/4	1 3/4
6	3 0	4 2 7/8	3	1 1/2	2 1/8
7	3 6 1/16	4 11 3/8	3 1/2	1 3/4	2 1/2
8	4 0 1/16	5 7 7/8	4	2	2 13/16
9	4 6 1/16	6 4 3/8	4 1/2	2 1/4	3 3/16
10	5 0 1/16	7 0 7/8	5	2 1/2	3 9/16
11	5 6 1/16	7 9 3/8	5 1/2	2 3/4	3 7/8
12	6 0 1/16	8 5 13/16	6	3	4 1/4
13	6 6 1/16	9 2 5/16	6 1/2	3 1/4	4 5/8
14	7 0 1/16	9 10 13/16	7	3 1/2	4 15/16
15	7 6 1/16	10 7 5/16	7 1/2	3 3/4	5 5/16
16	8 0 1/16	11 3 13/16	8	4	5 11/16
17	8 6 1/16	12 0 1/4	8 1/2	4 1/4	6
18	9 0 1/16	12 8 3/4	9	4 1/2	6 3/8
19	9 6 1/8	13 5 1/4	9 1/2	4 3/4	6 3/4
20	10 0 1/8	14 1 3/4	10	5	7 1/16
21	10 6 1/8	14 10 1/4	10 1/2	5 1/4	7 7/16
22	11 0 1/8	15 6 3/4	11	5 1/2	7 13/16
23	11 6 1/8	16 3 3/16	11 1/2	5 3/4	8 1/8
24	12 0 1/8	16 11 11/16	12	6	8 1/2
25	12 6 1/8	17 8 3/16			
26	13 0 1/8	18 4 11/16			
27	13 6 1/8	19 1 3/16			
28	14 0 1/8	19 9 11/16			
29	14 6 1/8	20 6 1/8			
30	15 0 1/8	21 2 5/8			
31	15 6 3/16	21 11 1/8			
32	16 0 3/16	22 7 5/8			
33	16 6 3/16	23 4 1/8			
34	17 0 3/16	24 0 9/16			
35	17 6 3/16	24 9 1/16			
36	18 0 3/16	25 5 9/16			
37	18 6 3/16	26 2 1/16			
38	19 0 3/16	26 10 9/16			
39	19 6 3/16	27 7 1/16			
40	20 0 3/16	28 3 1/2			
41	20 6 3/16	29 0			
42	21 0 3/16	29 8 1/2			
43	21 6 1/4	30 5			
44	22 0 1/4	31 1 1/2			
45	22 6 1/4	31 10			
46	23 0 1/4	32 6 7/16			
47	23 6 1/4	33 3			
48	24 0 1/4	33 11 7/16			
49	24 6 1/4	34 7 15/16			
50	25 0 1/4	35 4 7/16			
DIFFERENCE IN JACK RAFTER LENGTHS FOR RAFTER SPACINGS					
			ON CENTER	LENGTH DIFFERENCE	
				FEET	INCHES
			12"	1	0
			16"	1	4
			18"	1	6
			20"	1	8
			24"	2	0
PLUMB & SEAT CUTS FOR					
COMMON RAFTERS					
			PLUMB	SEAT	
			0 1/2	12	
HIP/VALLEY RAFTERS					
			PLUMB	SEAT	
			0 1/2	17	

RISE = 1 INCHES PER FOOT

BLDG WIDTH FEET	COMMON RAFTER FT INCHES	HIP/VALLEY RAFTER FT INCHES	ADD'L WIDTH INCHES	ADD'L COMMON LENGTH	ADDED HIP/VAL LENGTH
1	0 6	0 8 1/2	0 1/2	0 1/4	0 3/8
2	1 0 1/16	1 5	1	0 1/2	0 11/16
3	1 6 1/16	2 1 1/2	1 1/2	0 3/4	1 1/16
4	2 0 1/16	2 10	2	1	1 7/16
5	2 6 1/8	3 6 7/16	2 1/2	1 1/4	1 3/4
6	3 0 1/8	4 3	3	1 1/2	2 1/8
7	3 6 1/8	4 11 7/16	3 1/2	1 3/4	2 1/2
8	4 0 3/16	5 8	4	2	2 13/16
9	4 6 3/16	6 4 1/2	4 1/2	2 1/4	3 3/16
10	5 0 3/16	7 1	5	2 1/2	3 9/16
11	5 6 1/4	7 9 1/2	5 1/2	2 3/4	3 7/8
12	6 0 1/4	8 6	6	3	4 1/4
13	6 6 1/4	9 2 1/2	6 1/2	3 1/4	4 5/8
14	7 0 5/16	9 11	7	3 1/2	4 15/16
15	7 6 5/16	10 7 1/2	7 1/2	3 3/4	5 5/16
16	8 0 5/16	11 4	8	4	5 11/16
17	8 6 3/8	12 0 7/16	8 1/2	4 1/4	6
18	9 0 3/8	12 9	9	4 1/2	6 3/8
19	9 6 3/8	13 5 1/2	9 1/2	4 3/4	6 3/4
20	10 0 7/16	14 2	10	5	7 1/16
21	10 6 7/16	14 10 1/2	10 1/2	5 1/4	7 7/16
22	11 0 7/16	15 7	11	5 1/2	7 13/16
23	11 6 1/2	16 3 1/2	11 1/2	5 3/4	8 1/8
24	12 0 1/2	17 0	12	6	8 1/2
25	12 6 1/2	17 8 7/16			
26	13 0 9/16	18 5			
27	13 6 9/16	19 1 1/2			
28	14 0 9/16	19 10			
29	14 6 5/8	20 6 1/2			
30	15 0 5/8	21 3			
31	15 6 5/8	21 11 7/16			
32	16 0 11/16	22 8			
33	16 6 11/16	23 4 1/2			
34	17 0 11/16	24 1			
35	17 6 3/4	24 9 1/2			
36	18 0 3/4	25 6			
37	18 6 3/4	26 2 7/16			
38	19 0 13/16	26 11			
39	19 6 13/16	27 7 1/2			
40	20 0 13/16	28 4			
41	20 6 7/8	29 0 1/2			
42	21 0 7/8	29 9			
43	21 6 7/8	30 5 7/16			
44	22 0 15/16	31 2			
45	22 6 15/16	31 10 1/2			
46	23 0 15/16	32 7			
47	23 7	33 3 7/16			
48	24 1	34 0			
49	24 7	34 8 1/2			
50	25 1 1/16	35 5			

DIFFERENCE IN JACK RAFTER LENGTHS FOR RAFTER SPACINGS		
ON CENTER	LENGTH DIFFERENCE	
	FEET	INCHES
12"	1	0 1/16
16"	1	4 1/16
18"	1	6 1/16
20"	1	8 1/16
24"	2	0 1/16

PLUMB & SEAT CUTS FOR	
COMMON RAFTERS	
PLUMB 1	SEAT 12
HIP/VALLEY RAFTERS	
PLUMB 1	SEAT 17

RISE = 1.5 INCHES PER FOOT

BLDG WIDTH FEET	COMMON RAFTER FT INCHES	HIP/VALLEY RAFTER FT INCHES	ADD'L WIDTH INCHES	ADD'L COMMON LENGTH	ADDED HIP/VAL LENGTH
1	0 6 1/16	0 8 1/2	0 1/2	0 1/4	0 3/8
2	1 0 1/16	1 5	1	0 1/2	0 11/16
3	1 6 1/8	2 1 1/2	1 1/2	0 3/4	1 1/16
4	2 0 3/16	2 10 1/16	2	1	1 7/16
5	2 6 1/4	3 6 9/16	2 1/2	1 1/4	1 3/4
6	3 0 1/4	4 3 1/16	3	1 1/2	2 1/8
7	3 6 5/16	4 11 5/8	3 1/2	1 3/4	2 1/2
8	4 0 3/8	5 8 1/8	4	2	2 13/16
9	4 6 7/16	6 4 5/8	4 1/2	2 1/4	3 3/16
10	5 0 7/16	7 1 1/8	5	2 1/2	3 9/16
11	5 6 1/2	7 9 11/16	5 1/2	2 3/4	3 7/8
12	6 0 9/16	8 6 3/16	6	3	4 1/4
13	6 6 5/8	9 2 11/16	6 1/2	3 1/4	4 5/8
14	7 0 5/8	9 11 1/4	7	3 1/2	4 15/16
15	7 6 11/16	10 7 3/4	7 1/2	3 3/4	5 5/16
16	8 0 3/4	11 4 1/4	8	4	5 11/16
17	8 6 13/16	12 0 3/4	8 1/2	4 5/16	6 1/16
18	9 0 13/16	12 9 5/16	9	4 9/16	6 3/8
19	9 6 7/8	13 5 13/16	9 1/2	4 13/16	6 3/4
20	10 0 15/16	14 2 5/16	10	5 1/16	7 1/8
21	10 7	14 10 7/8	10 1/2	5 5/16	7 7/16
22	11 1	15 7 3/8	11	5 9/16	7 13/16
23	11 7 1/16	16 3 7/8	11 1/2	5 13/16	8 3/16
24	12 1 1/8	17 0 7/16	12	6 1/16	8 1/2
25	12 7 3/16	17 8 15/16			
26	13 1 3/16	18 5 7/16			
27	13 7 1/4	19 2			
28	14 1 5/16	19 10 1/2			
29	14 7 3/8	20 7			
30	15 1 3/8	21 3 1/2			
31	15 7 7/16	22 0 1/16			
32	16 1 1/2	22 8 9/16			
33	16 7 9/16	23 5 1/16			
34	17 1 9/16	24 1 9/16			
35	17 7 5/8	24 10 1/8			
36	18 1 11/16	25 6 5/8			
37	18 7 3/4	26 3 1/8			
38	19 1 3/4	26 11 11/16			
39	19 7 13/16	27 8 3/16			
40	20 1 7/8	28 4 11/16			
41	20 7 15/16	29 1 1/4			
42	21 1 15/16	29 9 3/4			
43	21 8	30 6 1/4			
44	22 2 1/16	31 2 3/4			
45	22 8 1/8	31 11 5/16			
46	23 2 1/8	32 7 13/16			
47	23 8 3/16	33 4 5/16			
48	24 2 1/4	34 0 7/8			
49	24 8 5/16	34 9 3/8			
50	25 2 5/16	35 5 7/8			

DIFFERENCE IN JACK RAFTER LENGTHS FOR RAFTER SPACINGS		
ON CENTER	LENGTH DIFFERENCE	
	FEET	INCHES
12"	1	0 1/16
16"	1	4 1/8
18"	1	6 1/8
20"	1	8 1/8
24"	2	0 3/16

PLUMB & SEAT CUTS FOR	
COMMON RAFTERS	
PLUMB	SEAT
1 1/2	12
HIP/VALLEY RAFTERS	
PLUMB	SEAT
1 1/2	17

RISE = 2 INCHES PER FOOT

BLDG WIDTH FEET	COMMON RAFTER FT INCHES	HIP/VALLEY RAFTER FT INCHES	ADD L WIDTH INCHES	ADD L COMMON LENGTH	ADDED HIP/VAL LENGTH
1	0 6 1/16	0 8 1/2	0 1/2	0 1/4	0 3/8
2	1 0 3/16	1 5 1/16	1	0 1/2	0 11/16
3	1 6 1/4	2 1 5/8	1 1/2	0 3/4	1 1/16
4	2 0 5/16	2 10 1/8	2	1	1 7/16
5	2 6 7/16	3 6 11/16	2 1/2	1 1/4	1 3/4
6	3 0 1/2	4 3 1/4	3	1 1/2	2 1/8
7	3 6 9/16	4 11 3/4	3 1/2	1 3/4	2 1/2
8	4 0 11/16	5 8 5/16	4	2	2 7/8
9	4 6 3/4	6 4 7/8	4 1/2	2 1/4	3 3/16
10	5 0 13/16	7 1 7/16	5	2 9/16	3 9/16
11	5 6 15/16	7 10	5 1/2	2 13/16	3 15/16
12	6 1	8 6 1/2	6	3 1/16	4 1/4
13	6 7 1/16	9 3 1/16	6 1/2	3 5/16	4 5/8
14	7 1 3/16	9 11 9/16	7	3 9/16	4 15/16
15	7 7 1/4	10 8 1/8	7 1/2	3 13/16	5 5/16
16	8 1 5/16	11 4 11/16	8	4 1/16	5 11/16
17	8 7 7/16	12 1 3/16	8 1/2	4 5/16	6 1/16
18	9 1 1/2	12 9 3/4	9	4 9/16	6 7/16
19	9 7 9/16	13 6 5/16	9 1/2	4 13/16	6 3/4
20	10 1 5/8	14 2 7/8	10	5 1/16	7 1/8
21	10 7 3/4	14 11 3/8	10 1/2	5 5/16	7 1/2
22	11 1 13/16	15 7 15/16	11	5 9/16	7 13/16
23	11 7 7/8	16 4 1/2	11 1/2	5 13/16	8 3/16
24	12 2	17 1	12	6 1/16	8 9/16
25	12 8 1/16	17 9 9/16	DIFFERENCE IN JACK RAFTER LENGTHS FOR RAFTER SPACINGS		
26	13 2 1/8	18 6 1/8			
27	13 8 1/4	19 2 11/16	ON CENTER		
28	14 2 5/16	19 11 3/16			
29	14 8 3/8	20 7 3/4	LENGTH DIFFERENCE		
30	15 2 1/2	21 4 5/16			
31	15 8 9/16	22 0 13/16	FEET		
32	16 2 5/8	22 9 3/8			
33	16 8 3/4	23 5 15/16	INCHES		
34	17 2 13/16	24 2 7/16			
35	17 8 7/8	24 11	12"	1	0 3/16
36	18 3	25 7 9/16	16"	1	4 1/4
37	18 9 1/16	26 4 1/8	18"	1	6 1/4
38	19 3 1/8	27 0 5/8	20"	1	8 1/4
39	19 9 1/4	27 9 3/16	24"	2	0 5/16
40	20 3 5/16	28 5 3/4	PLUMB & SEAT CUTS FOR		
41	20 9 3/8	29 2 1/4			
42	21 3 1/2	29 10 13/16	COMMON RAFTERS		
43	21 9 9/16	30 7 3/8			
44	22 3 5/8	31 3 7/8	PLUMB SEAT		
45	22 9 3/4	32 0 7/16			
46	23 3 13/16	32 9	HIP/VALLEY RAFTERS		
47	23 9 7/8	33 5 9/16			
48	24 4	34 2 1/16	PLUMB SEAT		
49	24 10 1/16	34 10 5/8			
50	25 4 1/8	35 7 3/16	2 17		

RISE = 2.5 INCHES PER FOOT

BLDG WIDTH FEET	COMMON RAFTER FT INCHES	HIP/VALLEY RAFTER FT INCHES	ADD L WIDTH INCHES	ADD'L COMMON LENGTH	ADDED HIP/VAL LENGTH
1	0 6 1/8	0 8 9/16	0 1/2	0 1/4	0 3/8
2	1 0 1/4	1 5 1/8	1	0 1/2	0 11/16
3	1 6 3/8	2 1 11/16	1 1/2	0 3/4	1 1/16
4	2 0 1/2	2 10 1/4	2	1	1 7/16
5	2 6 5/8	3 6 7/8	2 1/2	1 1/4	1 13/16
6	3 0 3/4	4 3 7/16	3	1 9/16	2 1/8
7	3 6 7/8	5 0	3 1/2	1 13/16	2 1/2
8	4 1	5 8 9/16	4	2 1/16	2 7/8
9	4 7 3/16	6 5 3/16	4 1/2	2 5/16	3 3/16
10	5 1 5/16	7 1 3/4	5	2 9/16	3 9/16
11	5 7 7/16	7 10 5/16	5 1/2	2 13/16	3 15/16
12	6 1 9/16	8 6 7/8	6	3 1/16	4 5/16
13	6 7 11/16	9 3 7/16	6 1/2	3 5/16	4 5/8
14	7 1 13/16	10 0 1/16	7	3 9/16	5
15	7 7 15/16	10 8 5/8	7 1/2	3 13/16	5 3/8
16	8 2 1/16	11 5 3/16	8	4 1/16	5 11/16
17	8 8 3/16	12 1 3/4	8 1/2	4 5/16	6 1/16
18	9 2 5/16	12 10 3/8	9	4 5/8	6 7/16
19	9 8 7/16	13 6 15/16	9 1/2	4 7/8	6 13/16
20	10 2 9/16	14 3 1/2	10	5 1/8	7 1/8
21	10 8 11/16	15 0 1/16	10 1/2	5 3/8	7 1/2
22	11 2 13/16	15 8 11/16	11	5 5/8	7 7/8
23	11 8 15/16	16 5 1/4	11 1/2	5 7/8	8 1/4
24	12 3 1/16	17 1 13/16	12	6 1/8	8 9/16
25	12 9 1/4	17 10 3/8			
26	13 3 3/8	18 7	DIFFERENCE IN JACK RAFTER LENGTHS FOR RAFTER SPACINGS		
27	13 9 1/2	19 3 9/16			
28	14 3 5/8	20 0 1/8			
29	14 9 3/4	20 8 11/16	ON CENTER	LENGTH DIFFERENCE	
30	15 3 7/8	21 5 1/4		FEET	INCHES
31	15 10	22 1 7/8	12"	1	0 1/4
32	16 4 1/8	22 10 7/16	16"	1	4 5/16
33	16 10 1/4	23 7	18"	1	6 3/8
34	17 4 3/8	24 3 9/16	20"	1	8 7/16
35	17 10 1/2	25 0 3/16	24"	2	0 1/2
36	18 4 5/8	25 8 3/4			
37	18 10 3/4	26 5 5/16			
38	19 4 7/8	27 1 7/8			
39	19 11	27 10 7/16	PLUMB & SEAT CUTS FOR		
40	20 5 1/8	28 7 1/16	COMMON RAFTERS		
41	20 11 5/16	29 3 5/8	PLUMB	SEAT	
42	21 5 7/16	30 0 3/16	2 1/2	12	
43	21 11 9/16	30 8 3/4			
44	22 5 11/16	31 5 3/8			
45	22 11 13/16	32 1 15/16	HIP/VALLEY RAFTERS		
46	23 5 15/16	32 10 1/2	PLUMB	SEAT	
47	24 0 1/16	33 7 1/16	2 1/2	17	
48	24 6 3/16	34 3 11/16			
49	25 0 5/16	35 0 1/4			
50	25 6 7/16	35 8 13/16			

RISE = 3 INCHES PER FOOT

BLOG WIDTH FEET	COMMON RAFTER FT INCHES	HIP/VALLEY RAFTER FT INCHES	ADD'L WIDTH INCHES	ADD'L COMMON LENGTH	ADDED HIP/VAL LENGTH
1	0 6 3/16	0 8 9/16	0 1/2	0 1/4	0 3/8
2	1 0 3/8	1 5 3/16	1	0 1/2	0 11/16
3	1 6 9/16	2 1 13/16	1 1/2	0 3/4	1 1/16
4	2 0 3/4	2 10 7/16	2	1	1 7/16
5	2 6 15/16	3 7 1/16	2 1/2	1 5/16	1 13/16
6	3 1 1/8	4 3 11/16	3	1 9/16	2 1/8
7	3 7 5/16	5 0 5/16	3 1/2	1 13/16	2 1/2
8	4 1 1/2	5 8 7/8	4	2 1/16	2 7/8
9	4 7 11/16	6 5 1/2	4 1/2	2 5/16	3 1/4
10	5 1 7/8	7 2 1/8	5	2 9/16	3 9/16
11	5 8	7 10 3/4	5 1/2	2 13/16	3 15/16
12	6 2 3/16	8 7 3/8	6	3 1/16	4 5/16
13	6 8 3/8	9 4	6 1/2	3 3/8	4 11/16
14	7 2 9/16	10 0 5/8	7	3 5/8	5
15	7 8 3/4	10 9 1/4	7 1/2	3 7/8	5 3/8
16	8 2 15/16	11 5 13/16	8	4 1/8	5 3/4
17	8 9 1/8	12 2 7/16	8 1/2	4 3/8	6 1/8
18	9 3 5/16	12 11 1/16	9	4 5/8	6 7/16
19	9 9 1/2	13 7 11/16	9 1/2	4 7/8	6 13/16
20	10 3 11/16	14 4 5/16	10	5 1/8	7 3/16
21	10 9 7/8	15 0 15/16	10 1/2	5 7/16	7 9/16
22	11 4 1/16	15 9 9/16	11	5 11/16	7 7/8
23	11 10 1/4	16 6 1/8	11 1/2	5 15/16	8 1/4
24	12 4 7/16	17 2 3/4	12	6 3/16	8 5/8
25	12 10 5/8	17 11 3/8			
26	13 4 13/16	18 8	DIFFERENCE IN JACK RAFTER LENGTHS FOR RAFTER SPACINGS		
27	13 11	19 4 5/8			
28	14 5 3/16	20 1 1/4			
29	14 11 3/8	20 9 7/8			
30	15 5 9/16	21 6 1/2	ON CENTER	LENGTH DIFFERENCE	
31	15 11 3/4	22 3 1/16		FEET	INCHES
32	16 5 15/16	22 11 11/16	12"	1	0 3/8
33	17 0 1/16	23 8 5/16	16"	1	4 1/2
34	17 6 1/4	24 5	18"	1	6 9/16
35	18 0 7/16	25 1 9/16	20"	1	8 5/8
36	18 6 5/8	25 10 3/16	24"	2	0 3/4
37	19 0 13/16	26 6 13/16			
38	19 7	27 3 7/16			
39	20 1 3/16	28 0	PLUMB & SEAT CUTS FOR		
40	20 7 3/8	28 8 5/8	COMMON RAFTERS		
41	21 1 9/16	29 5 1/4	PLUMB	SEAT	
42	21 7 3/4	30 1 7/8	3	12	
43	22 1 15/16	30 10 1/2	HIP/VALLEY RAFTERS		
44	22 8 1/8	31 7 1/8	PLUMB	SEAT	
45	23 2 5/16	32 3 3/4	3	17	
46	23 8 1/2	33 0 5/16			
47	24 2 11/16	33 9			
48	24 8 7/8	34 5 9/16			
49	25 3 1/16	35 2 3/16			
50	25 9 1/4	35 10 13/16			

RISE = 3.5 INCHES PER FOOT

BLOG WIDTH FEET	COMMON RAFTER FT INCHES	HIP/VALLEY RAFTER FT INCHES	ADD L WIDTH INCHES	ADD'L COMMON LENGTH	ADDED HIP/VAL LENGTH
1	0 6 1/4	0 8 5/8	0 1/2	0 1/4	0 3/8
2	1 0 1/2	1 5 5/16	1	0 1/2	0 3/4
3	1 6 3/4	2 2	1 1/2	0 13/16	1 1/16
4	2 1	2 10 5/8	2	1 1/16	1 7/16
5	2 7 1/4	3 7 5/16	2 1/2	1 5/16	1 13/16
6	3 1 1/2	4 4	3	1 9/16	2 3/16
7	3 7 3/4	5 0 5/8	3 1/2	1 13/16	2 1/2
8	4 2	5 9 1/4	4	2 1/16	2 7/8
9	4 8 1/4	6 6	4 1/2	2 3/8	3 1/4
10	5 2 1/2	7 2 5/8	5	2 5/8	3 5/8
11	5 8 3/4	7 11 1/4	5 1/2	2 7/8	3 15/16
12	6 3	8 7 15/16	6	3 1/8	4 5/16
13	6 9 1/4	9 4 5/8	6 1/2	3 3/8	4 11/16
14	7 3 1/2	10 1 1/4	7	3 5/8	5 1/16
15	7 9 3/4	10 9 15/16	7 1/2	3 15/16	5 7/16
16	8 4	11 6 9/16	8	4 3/16	5 3/4
17	8 10 1/4	12 3 1/4	8 1/2	4 7/16	6 1/8
18	9 4 1/2	12 11 15/16	9	4 11/16	6 1/2
19	9 10 3/4	13 8 9/16	9 1/2	4 15/16	6 7/8
20	10 5	14 5 1/4	10	5 3/16	7 1/4
21	10 11 1/4	15 1 15/16	10 1/2	5 1/2	7 9/16
22	11 5 1/2	15 10 9/16	11	5 3/4	7 15/16
23	11 11 3/4	16 7 1/4	11 1/2	5 15/16	8 5/16
24	12 6	17 3 7/8	12	6 1/4	8 11/16
25	13 0 1/4	18 0 9/16	DIFFERENCE IN JACK RAFTER LENGTHS FOR RAFTER SPACINGS		
26	13 6 1/2	18 9 1/4	ON CENTER LENGTH DIFFERENCE		
27	14 0 3/4	19 5 7/8			
28	14 7	20 2 9/16	FEET INCHES		
29	15 1 1/4	20 11 1/4			
30	15 7 1/2	21 7 7/8	12"	1	0 1/2
31	16 1 3/4	22 4 9/16	16"	1	4 11/16
32	16 8	23 1 3/16	18"	1	6 3/4
33	17 2 1/4	23 9 7/8	20"	1	8 13/16
34	17 8 1/2	24 6 9/16	24"	2	1
35	18 2 3/4	25 3 3/16	PLUMB & SEAT CUTS FOR		
36	18 9	25 11 7/8	COMMON RAFTERS		
37	19 3 1/4	26 8 9/16	PLUMB SEAT		
38	19 9 1/2	27 5 3/16	3 1/2 12		
39	20 3 3/4	28 1 7/8	HIP/VALLEY RAFTERS		
40	20 10	28 10 1/2	PLUMB SEAT		
41	21 4 1/4	29 7 3/16	3 1/2 17		
42	21 10 1/2	30 3 7/8			
43	22 4 3/4	31 0 1/2			
44	22 11	31 9 3/16			
45	23 5 1/4	32 5 13/16			
46	23 11 1/2	33 2 1/2			
47	24 5 3/4	33 11 3/16			
48	25 0	34 7 13/16			
49	25 6 1/4	35 4 1/2			
50	26 0 1/2	36 1 3/16			

RISE = 4 INCHES PER FOOT

BLDG WIDTH FEET	COMMON RAFTER FT INCHES	HIP/VALLEY RAFTER FT INCHES	ADD'L WIDTH INCHES	ADD'L COMMON LENGTH	ADDED HIP/VAL LENGTH
1	0 6 5/16	0 8 11/16	0 1/2	0 1/4	0 3/8
2	1 0 5/8	1 5 3/8	1	0 1/2	0 3/4
3	1 7	2 2 1/8	1 1/2	0 13/16	1 1/16
4	2 1 5/16	2 10 13/16	2	1 1/16	1 7/16
5	2 7 5/8	3 7 9/16	2 1/2	1 5/16	1 13/16
6	3 1 15/16	4 4 1/4	3	1 9/16	2 3/16
7	3 8 1/4	5 1	3 1/2	1 7/8	2 9/16
8	4 2 5/8	5 9 11/16	4	2 1/8	2 7/8
9	4 8 15/16	6 6 7/16	4 1/2	2 3/8	3 1/4
10	5 3 1/4	7 3 1/8	5	2 5/8	3 5/8
11	5 9 9/16	7 11 7/8	5 1/2	2 7/8	3 15/16
12	6 3 7/8	8 8 9/16	6	3 3/16	4 3/8
13	6 10 1/4	9 5 5/16	6 1/2	3 7/16	4 3/4
14	7 4 9/16	10 2	7	3 11/16	5 1/16
15	7 10 7/8	10 10 3/4	7 1/2	3 15/16	5 7/16
16	8 5 3/16	11 7 7/16	8	4 3/16	5 13/16
17	8 11 1/2	12 4 3/16	8 1/2	4 1/2	6 3/16
18	9 5 13/16	13 0 7/8	9	4 3/4	6 9/16
19	10 0 3/16	13 9 5/8	9 1/2	5	6 7/8
20	10 6 1/2	14 6 5/16	10	5 1/4	7 1/4
21	11 0 13/16	15 3 1/16	10 1/2	5 9/16	7 5/8
22	11 7 1/8	15 11 3/4	11	5 13/16	7 15/16
23	12 1 7/16	16 8 1/2	11 1/2	6 1/16	8 3/8
24	12 7 13/16	17 5 3/16	12	6 5/16	8 11/16
25	13 2 1/8	18 1 15/16			
26	13 8 7/16	18 10 5/8			
27	14 2 3/4	19 7 3/8			
28	14 9 1/16	20 4 1/16			
29	15 3 7/16	21 0 13/16			
30	15 9 3/4	21 9 1/2			
31	16 4 1/16	22 6 1/4			
32	16 10 3/8	23 3			
33	17 4 11/16	23 11 5/8			
34	17 11 1/16	24 8 3/8			
35	18 5 3/8	25 5 1/16			
36	18 11 11/16	26 1 13/16			
37	19 6	26 10 1/2			
38	20 0 5/16	27 7 1/4			
39	20 6 11/16	28 4			
40	21 1	29 0 11/16			
41	21 7 5/16	29 9 3/8			
42	22 1 5/8	30 6 1/8			
43	22 7 15/16	31 2 13/16			
44	23 2 1/4	31 11 9/16			
45	23 8 5/8	32 8 1/4			
46	24 2 15/16	33 5			
47	24 9 1/4	34 1 11/16			
48	25 3 9/16	34 10 7/16			
49	25 9 7/8	35 7 1/8			
50	26 4 1/4	36 3 7/8			

DIFFERENCE IN JACK RAFTER LENGTHS FOR RAFTER SPACINGS		
ON CENTER	LENGTH DIFFERENCE	
	FEET	INCHES
12"	1	0 5/8
16"	1	4 7/8
18"	1	6 15/16
20"	1	9 1/16
24"	2	1 5/16

PLUMB & SEAT CUTS FOR	
COMMON RAFTERS	
PLUMB 4	SEAT 12
HIP/VALLEY RAFTERS	
PLUMB 4	SEAT 17

RISE = 4.5 INCHES PER FOOT

BLDG WIDTH FEET	COMMON RAFTER FT INCHES	HIP/VALLEY RAFTER FT INCHES	ADD'L WIDTH INCHES	ADD'L COMMON LENGTH	ADDED HIP/VAL LENGTH
1	0 6 7/16	0 8 3/4	0 1/2	0 1/4	0 3/8
2	1 0 13/16	1 5 1/2	1	0 9/16	0 3/4
3	1 7 1/4	2 2 5/16	1 1/2	0 13/16	1 1/8
4	2 1 5/8	2 11 1/16	2	1 1/16	1 7/16
5	2 8 1/16	3 7 7/8	2 1/2	1 5/16	1 13/16
6	3 2 7/16	4 4 5/8	3	1 5/8	2 3/16
7	3 8 7/8	5 1 7/16	3 1/2	1 7/8	2 9/16
8	4 3 1/4	5 10 3/16	4	2 1/8	2 15/16
9	4 9 11/16	6 7	4 1/2	2 3/8	3 5/16
10	5 4 1/16	7 3 3/4	5	2 11/16	3 11/16
11	5 10 1/2	8 0 9/16	5 1/2	2 15/16	4
12	6 4 7/8	8 9 5/16	6	3 3/16	4 3/8
13	6 11 5/16	9 6 1/16	6 1/2	3 1/2	4 3/4
14	7 5 11/16	10 2 7/8	7	3 3/4	5 1/8
15	8 0 1/8	10 11 5/8	7 1/2	4	5 1/2
16	8 6 1/2	11 8 7/16	8	4 1/4	5 7/8
17	9 0 15/16	12 5 3/16	8 1/2	4 9/16	6 3/16
18	9 7 3/8	13 2	9	4 13/16	6 9/16
19	10 1 3/4	13 10 3/4	9 1/2	5 1/16	6 15/16
20	10 8 3/16	14 7 9/16	10	5 5/16	7 5/16
21	11 2 9/16	15 4 5/16	10 1/2	5 5/8	7 11/16
22	11 9	16 1 1/8	11	5 7/8	8 1/16
23	12 3 3/8	16 9 7/8	11 1/2	6 1/8	8 7/16
24	12 9 13/16	17 6 5/8	12	6 7/16	8 3/4
25	13 4 3/16	18 3 7/16			
26	13 10 5/8	19 0 3/16			
27	14 5	19 9			
28	14 11 7/16	20 5 3/4			
29	15 5 13/16	21 2 9/16			
30	16 0 1/4	21 11 5/16			
31	16 6 5/8	22 8 1/8			
32	17 1 1/16	23 4 7/8			
33	17 7 7/16	24 1 11/16			
34	18 1 7/8	24 10 7/16			
35	18 8 1/4	25 7 3/16			
36	19 2 11/16	26 4			
37	19 9 1/8	27 0 3/4			
38	20 3 1/2	27 9 9/16			
39	20 9 15/16	28 6 5/16			
40	21 4 5/16	29 3 1/8			
41	21 10 3/4	29 11 7/8			
42	22 5 1/8	30 8 11/16			
43	22 11 9/16	31 5 7/16			
44	23 5 15/16	32 2 1/4			
45	24 0 3/8	32 11			
46	24 6 3/4	33 7 3/4			
47	25 1 3/16	34 4 9/16			
48	25 7 9/16	35 1 5/16			
49	26 2	35 10 1/8			
50	26 8 3/8	36 6 7/8			

DIFFERENCE IN JACK RAFTER LENGTHS FOR RAFTER SPACINGS		
ON CENTER	LENGTH DIFFERENCE	
	FEET	INCHES
12"	1	0 13/16
16"	1	5 1/16
18"	1	7 1/4
20"	1	9 3/8
24"	2	1 5/8

PLUMB & SEAT CUTS FOR	
COMMON RAFTERS	
PLUMB	SEAT
4 1/2	12
HIP/VALLEY RAFTERS	
PLUMB	SEAT
4 1/2	17

RISE = 5 INCHES PER FOOT

BLDG WIDTH FEET	COMMON RAFTER FT INCHES	HIP/VALLEY RAFTER FT INCHES	ADD'L WIDTH INCHES	ADD'L COMMON LENGTH	ADDED HIP/VAL LENGTH
1	0 6 1/2	0 8 13/16	0 1/2	0 1/4	0 3/8
2	1 1	1 5 11/16	1	0 9/16	0 3/4
3	1 7 1/2	2 2 1/2	1 1/2	0 13/16	1 1/8
4	2 2	2 11 3/8	2	1 1/16	1 1/2
5	2 8 1/2	3 8 3/16	2 1/2	1 3/8	1 13/16
6	3 3	4 5 1/16	3	1 5/8	2 3/16
7	3 9 1/2	5 1 7/8	3 1/2	1 7/8	2 9/16
8	4 4	5 10 3/4	4	2 3/16	2 15/16
9	4 10 1/2	6 7 9/16	4 1/2	2 7/16	3 5/16
10	5 5	7 4 7/16	5	2 11/16	3 11/16
11	5 11 1/2	8 1 1/4	5 1/2	2 15/16	4 1/16
12	6 6	8 10 1/8	6	3 1/4	4 7/16
13	7 0 1/2	9 7	6 1/2	3 1/2	4 13/16
14	7 7	10 3 13/16	7	3 13/16	5 3/16
15	8 1 1/2	11 0 11/16	7 1/2	4 1/16	5 1/2
16	8 8	11 9 1/2	8	4 5/16	5 7/8
17	9 2 1/2	12 6 3/8	8 1/2	4 5/8	6 1/4
18	9 9	13 3 3/16	9	4 7/8	6 5/8
19	10 3 1/2	14 0 1/16	9 1/2	5 1/8	7
20	10 10	14 8 7/8	10	5 7/16	7 3/8
21	11 4 1/2	15 5 3/4	10 1/2	5 11/16	7 3/4
22	11 11	16 2 9/16	11	5 15/16	8 1/8
23	12 5 1/2	16 11 7/16	11 1/2	6 1/4	8 1/2
24	13 0	17 8 1/4	12	6 1/2	8 7/8
25	13 6 1/2	18 5 1/8			
26	14 1	19 2			
27	14 7 1/2	19 10 13/16			
28	15 2	20 7 5/8			
29	15 8 1/2	21 4 1/2			
30	16 3	22 1 3/8			
31	16 9 1/2	22 10 3/16			
32	17 4	23 7 1/16			
33	17 10 1/2	24 3 7/8			
34	18 5	25 0 3/4			
35	18 11 1/2	25 9 9/16			
36	19 6	26 8 7/16			
37	20 0 1/2	27 3 1/4			
38	20 7	28 0 1/8			
39	21 1 1/2	28 9			
40	21 8	29 5 13/16			
41	22 2 1/2	30 2 5/8			
42	22 9	30 11 1/2			
43	23 3 1/2	31 8 5/16			
44	23 10	32 5 3/16			
45	24 4 1/2	33 2 1/16			
46	24 11	33 10 7/8			
47	25 5 1/2	34 7 3/4			
48	26 0	35 4 9/16			
49	26 6 1/2	36 1 7/16			
50	27 1	36 10 1/4			

DIFFERENCE IN JACK RAFTER LENGTHS FOR RAFTER SPACINGS		
ON CENTER	LENGTH DIFFERENCE	
	FEET	INCHES
12"	1	1
16"	1	5 5/16
18"	1	7 1/2
20"	1	9 11/16
24"	2	1 15/16

PLUMB & SEAT CUTS FOR	
COMMON RAFTERS	
PLUMB	SEAT
5	12
HIP/VALLEY RAFTERS	
PLUMB	SEAT
5	17

RISE = 5.5 INCHES PER FOOT

BLDG WIDTH FEET	COMMON RAFTER FT INCHES	HIP/VALLEY RAFTER FT INCHES	ADD'L WIDTH INCHES	ADD'L COMMON LENGTH	ADDED HIP/VAL LENGTH
1	0 6 5/8	0 8 7/8	0 1/2	0 1/4	0 3/8
2	1 1 3/16	1 5 13/16	1	0 9/16	0 3/4
3	1 7 13/16	2 2 3/4	1 1/2	0 13/16	1 1/8
4	2 2 3/8	2 11 5/8	2	1 1/8	1 1/2
5	2 9	3 8 9/16	2 1/2	1 3/8	1 7/8
6	3 3 5/8	4 5 1/2	3	1 5/8	2 1/4
7	3 10 3/16	5 2 7/16	3 1/2	1 15/16	2 5/8
8	4 4 13/16	5 11 5/16	4	2 3/16	2 15/16
9	4 11 3/8	6 8 1/4	4 1/2	2 1/2	3 3/8
10	5 6	7 5 3/16	5	2 3/4	3 11/16
11	6 0 5/8	8 2 1/16	5 1/2	3	4 1/16
12	6 7 3/16	8 11	6	3 5/16	4 7/16
13	7 1 13/16	9 7 15/16	6 1/2	3 9/16	4 13/16
14	7 8 3/8	10 4 7/8	7	3 7/8	5 3/16
15	8 3	11 1 3/4	7 1/2	4 1/8	5 9/16
16	8 9 5/8	11 10 11/16	8	4 3/8	5 15/16
17	9 4 3/16	12 7 5/8	8 1/2	4 11/16	6 5/16
18	9 10 13/16	13 4 1/2	9	4 15/16	6 11/16
19	10 5 3/8	14 1 7/16	9 1/2	5 1/4	7 1/16
20	11 0	14 10 3/8	10	5 1/2	7 7/16
21	11 6 5/8	15 7 5/16	10 1/2	5 3/4	7 13/16
22	12 1 3/16	16 4 3/16	11	6 1/16	8 3/16
23	12 7 13/16	17 1 1/8	11 1/2	6 5/16	8 9/16
24	13 2 3/8	17 10 1/16	12	6 5/8	8 15/16
25	13 9	18 7			
26	14 3 5/8	19 3 7/8			
27	14 10 3/16	20 0 13/16			
28	15 4 13/16	20 9 3/4			
29	15 11 3/8	21 6 5/8			
30	16 6	22 3 9/16			
31	17 0 5/8	23 0 1/2			
32	17 7 3/16	23 9 3/8			
33	18 1 13/16	24 6 5/16			
34	18 8 7/16	25 3 1/4			
35	19 3	26 0 3/16			
36	19 9 5/8	26 9 1/16			
37	20 4 3/16	27 6			
38	20 10 13/16	28 2 15/16			
39	21 5 7/16	28 11 13/16			
40	22 0	29 8 3/4			
41	22 6 5/8	30 5 11/16			
42	23 1 3/16	31 2 5/8			
43	23 7 13/16	31 11 1/2			
44	24 2 7/16	32 8 7/16			
45	24 9	33 5 3/8			
46	25 3 5/8	34 2 1/4			
47	25 10 3/16	34 11 3/16			
48	26 4 13/16	35 8 1/8			
49	26 11 7/16	36 5 1/16			
50	27 6	37 2			

DIFFERENCE IN JACK RAFTER LENGTHS FOR RAFTER SPACINGS		
ON CENTER	LENGTH DIFFERENCE	
	FEET	INCHES
12"	1	1 3/16
16"	1	5 5/8
18"	1	7 13/16
20"	1	10
24"	2	2 3/8

PLUMB & SEAT CUTS FOR	
COMMON RAFTERS	
PLUMB	SEAT
5 1/2	12
HIP/VALLEY RAFTERS	
PLUMB	SEAT
5 1/2	17

RISE = 6 INCHES PER FOOT

BLDG WIDTH FEET	COMMON RAFTER FT INCHES	HIP/VALLEY RAFTER FT INCHES	ADD'L WIDTH INCHES	ADD'L COMMON LENGTH	ADDED HIP/VAL LENGTH
1	0 6 11/16	0 9	0 1/2	0 1/4	0 3/8
2	1 1 7/16	1 6	1	0 9/16	0 3/4
3	1 8 1/8	2 3	1 1/2	0 13/16	1 1/8
4	2 2 13/16	3 0	2	1 1/8	1 1/2
5	2 9 9/16	3 9	2 1/2	1 3/8	1 7/8
6	3 4 1/4	4 6	3	1 11/16	2 1/4
7	3 10 15/16	5 3	3 1/2	1 15/16	2 5/8
8	4 5 11/16	6 0	4	2 1/4	3
9	5 0 3/8	6 9	4 1/2	2 1/2	3 3/8
10	5 7 1/16	7 6	5	2 13/16	3 3/4
11	6 1 13/16	8 3	5 1/2	3 1/16	4 1/8
12	6 8 1/2	9 0	6	3 3/8	4 1/2
13	7 3 3/16	9 9	6 1/2	3 5/8	4 7/8
14	7 9 15/16	10 6	7	3 15/16	5 1/4
15	8 4 5/8	11 3	7 1/2	4 3/16	5 5/8
16	8 11 5/16	12 0	8	4 1/2	6
17	9 6 1/16	12 9	8 1/2	4 3/4	6 3/8
18	10 0 3/4	13 6	9	5	6 3/4
19	10 7 7/16	14 3	9 1/2	5 5/16	7 1/8
20	11 2 3/16	15 0	10	5 9/16	7 1/2
21	11 8 7/8	15 9	10 1/2	5 7/8	7 7/8
22	12 3 9/16	16 6	11	6 1/8	8 1/4
23	12 10 5/16	17 3	11 1/2	6 7/16	8 5/8
24	13 5	18 0	12	6 11/16	9
25	13 11 11/16	18 9			
26	14 6 7/16	19 6			
27	15 1 1/8	20 3			
28	15 7 13/16	21 0			
29	16 2 9/16	21 9			
30	16 9 1/4	22 6			
31	17 3 15/16	23 3			
32	17 10 11/16	24 0			
33	18 5 3/8	24 9			
34	19 0 1/16	25 6			
35	19 6 13/16	26 3			
36	20 1 1/2	27 0			
37	20 8 3/16	27 9			
38	21 2 15/16	28 6			
39	21 9 5/8	29 3			
40	22 4 5/16	30 0			
41	22 11 1/16	30 9			
42	23 5 3/4	31 6			
43	24 0 7/16	32 3			
44	24 7 3/16	33 0			
45	25 1 7/8	33 9			
46	25 8 9/16	34 6			
47	26 3 5/16	35 3			
48	26 10	36 0			
49	27 4 11/16	36 9			
50	27 11 7/16	37 6			

DIFFERENCE IN JACK RAFTER LENGTHS FOR RAFTER SPACINGS		
ON CENTER	LENGTH DIFFERENCE	
	FEET	INCHES
12"	1	1 7/16
16"	1	5 7/8
18"	1	8 1/8
20"	1	10 3/8
24"	2	2 13/16

PLUMB & SEAT CUTS FOR	
COMMON RAFTERS	
PLUMB 6	SEAT 12
HIP/VALLEY RAFTERS	
PLUMB 6	SEAT 17

RISE = 6.5 INCHES PER FOOT

BLDG WIDTH FEET	COMMON RAFTER FT INCHES	HIP/VALLEY RAFTER FT INCHES	ADD'L WIDTH INCHES	ADD L COMMON LENGTH	ADDED HIP/VAL LENGTH			
1	0 6 13/16	0 9 1/16	0 1/2	0 5/16	0 3/8			
2	1 1 5/8	1 6 1/8	1	0 9/16	0 3/4			
3	1 8 1/2	2 3 1/4	1 1/2	0 7/8	1 1/8			
4	2 3 5/16	3 0 5/16	2	1 1/8	1 1/2			
5	2 10 1/8	3 9 3/8	2 1/2	1 7/16	1 7/8			
6	3 4 15/16	4 6 1/2	3	1 11/16	2 1/4			
7	3 11 3/4	5 3 9/16	3 1/2	1 15/16	2 5/8			
8	4 6 9/16	6 0 11/16	4	2 1/4	3			
9	5 1 7/16	6 9 3/4	4 1/2	2 9/16	3 7/16			
10	5 8 1/4	7 6 13/16	5	2 13/16	3 13/16			
11	6 3 1/16	8 3 15/16	5 1/2	3 1/8	4 3/16			
12	6 9 7/8	9 1	6	3 7/16	4 9/16			
13	7 4 11/16	9 10 1/16	6 1/2	3 11/16	4 15/16			
14	7 11 9/16	10 7 3/16	7	3 15/16	5 5/16			
15	8 6 3/8	11 4 1/4	7 1/2	4 1/4	5 11/16			
16	9 1 3/16	12 1 3/8	8	4 9/16	6 1/16			
17	9 8	12 10 7/16	8 1/2	4 13/16	6 7/16			
18	10 2 13/16	13 7 1/2	9	5 1/8	6 13/16			
19	10 9 5/8	14 4 5/8	9 1/2	5 3/8	7 3/16			
20	11 4 1/2	15 1 11/16	10	5 11/16	7 9/16			
21	11 11 5/16	15 10 13/16	10 1/2	5 15/16	7 15/16			
22	12 6 1/8	16 7 7/8	11	6 1/4	8 5/16			
23	13 0 15/16	17 5	11 1/2	6 9/16	8 11/16			
24	13 7 3/4	18 2 1/16	12	6 13/16	9 1/16			
25	14 2 9/16	18 11 1/8	DIFFERENCE IN JACK RAFTER LENGTHS FOR RAFTER SPACINGS					
26	14 9 7/16	19 8 3/16	ON CENTER LENGTH DIFFERENCE					
27	15 4 1/4	20 5 5/16						
28	15 11 1/16	21 2 3/8	FEET INCHES					
29	16 5 7/8	21 11 1/2						
30	17 0 11/16	22 8 9/16	12" 1 1 5/8					
31	17 7 9/16	23 5 5/8						
32	18 2 3/8	24 2 3/4				16" 1 6 3/16		
33	18 9 3/16	24 11 13/16						
34	19 4	25 8 7/8						
35	19 10 13/16	26 6						
36	20 5 5/8	27 3 1/16	20" 1 10 3/4					
37	21 0 1/2	28 0 3/16						
38	21 7 5/16	28 9 1/4				24" 2 3 5/16		
39	22 2 1/8	29 6 5/16						
40	22 8 15/16	30 3 7/16						
41	23 3 3/4	31 0 1/2						
42	23 10 5/8	31 9 5/8						
43	24 5 7/16	32 6 11/16	COMMON RAFTERS					
44	25 0 1/4	33 3 3/4	PLUMB SEAT					
45	25 7 1/16	34 0 7/8	6 1/2 12					
46	26 1 7/8	34 10	HIP/VALLEY RAFTERS					
47	26 8 11/16	35 7	PLUMB SEAT					
48	27 3 9/16	36 4 1/8	6 1/2 17					
49	27 10 3/8	37 1 3/16						
50	28 5 3/16	37 10 5/16						

RISE = 7 INCHES PER FOOT

BLDG WIDTH FEET	COMMON RAFTER FT INCHES	HIP/VALLEY RAFTER FT INCHES	ADD L WIDTH INCHES	ADD L COMMON LENGTH	ADDED HIP/VAL LENGTH
1	0 6 15/16	0 9 1/8	0 1/2	0 5/16	0 3/8
2	1 1 7/8	1 6 5/16	1	0 9/16	0 3/4
3	1 8 13/16	2 3 1/2	1 1/2	0 7/8	1 1/8
4	2 3 13/16	3 0 11/16	2	1 3/16	1 1/2
5	2 10 3/4	3 9 7/8	2 1/2	1 7/16	1 15/16
6	3 5 11/16	4 7 1/16	3	1 3/4	2 5/16
7	4 0 5/8	5 4 1/4	3 1/2	2	2 11/16
8	4 7 9/16	6 1 3/8	4	2 5/16	3 1/16
9	5 2 1/2	6 10 9/16	4 1/2	2 5/8	3 7/16
10	5 9 7/16	7 7 3/4	5	2 7/8	3 13/16
11	6 4 7/16	8 4 15/16	5 1/2	3 3/16	4 3/16
12	6 11 3/8	9 2 1/8	6	3 1/2	4 9/16
13	7 6 5/16	9 11 5/16	6 1/2	3 3/4	4 15/16
14	8 1 1/4	10 8 1/2	7	4 1/16	5 3/8
15	8 8 3/16	11 5 5/8	7 1/2	4 5/16	5 3/4
16	9 3 1/8	12 2 13/16	8	4 5/8	6 1/8
17	9 10 1/16	13 0	8 1/2	4 15/16	6 1/2
18	10 5 1/16	13 9 3/16	9	5 3/16	6 7/8
19	10 12	14 6 3/8	9 1/2	5 1/2	7 1/4
20	11 6 15/16	15 3 9/16	10	5 13/16	7 5/8
21	12 1 7/8	16 0 3/4	10 1/2	6 1/16	8 1/16
22	12 8 13/16	16 9 7/8	11	6 3/8	8 7/16
23	13 3 3/4	17 7 1/16	11 1/2	6 11/16	8 13/16
24	13 10 11/16	18 4 1/4	12	6 15/16	9 3/16
25	14 5 5/8	19 1 7/16			
26	15 0 5/8	19 10 5/8			
27	15 7 9/16	20 7 13/16			
28	16 2 1/2	21 5			
29	16 9 7/16	22 2 1/8			
30	17 4 3/8	22 11 5/16			
31	17 11 5/16	23 8 1/2			
32	18 6 1/4	24 5 11/16			
33	19 1 1/4	25 2 7/8			
34	19 8 3/16	26 0 1/16			
35	20 3 1/8	26 9 1/4			
36	20 10 1/16	27 6 3/8			
37	21 5	28 3 9/16			
38	21 11 15/16	29 0 3/4			
39	22 6 7/8	29 10			
40	23 1 7/8	30 7 1/8			
41	23 8 13/16	31 4 5/16			
42	24 3 3/4	32 1 1/2			
43	24 10 11/16	32 10 11/16			
44	25 5 5/8	33 7 13/16			
45	26 0 9/16	34 5			
46	26 7 1/2	35 2 3/16			
47	27 2 1/2	35 11 3/8			
48	27 9 7/16	36 8 9/16			
49	28 4 3/8	37 5 3/4			
50	28 11 5/16	38 2 15/16			

DIFFERENCE IN JACK RAFTER LENGTHS FOR RAFTER SPACINGS		
ON CENTER	LENGTH DIFFERENCE	
	FEET	INCHES
12"	1	1 7/8
16"	1	6 1/2
18"	1	8 13/16
20"	1	11 1/8
24"	2	3 13/16

PLUMB & SEAT CUTS FOR	
COMMON RAFTERS	
PLUMB 7	SEAT 12
HIP/VALLEY RAFTERS	
PLUMB 7	SEAT 17

RISE = 7.5 INCHES PER FOOT

BLDG WIDTH FEET	COMMON RAFTER FT INCHES	HIP/VALLEY RAFTER FT INCHES	ADD'L WIDTH INCHES	ADD'L COMMON LENGTH	ADDED HIP/VAL LENGTH
1	0 7 1/16	0 9 1/4	0 1/2	0 5/16	0 3/8
2	1 2 1/8	1 6 1/2	1	0 9/16	0 3/4
3	1 9 1/4	2 3 13/16	1 1/2	0 7/8	1 3/16
4	2 4 5/16	3 1 1/16	2	1 3/16	1 9/16
5	2 11 3/8	3 10 3/8	2 1/2	1 1/2	1 15/16
6	3 6 7/16	4 7 5/8	3	1 3/4	2 5/16
7	4 1 1/2	5 4 15/16	3 1/2	2 1/16	2 11/16
8	4 8 5/8	6 2 3/16	4	2 3/8	3 1/16
9	5 3 11/16	6 11 7/16	4 1/2	2 5/8	3 1/2
10	5 10 3/4	7 8 3/4	5	2 15/16	3 7/8
11	6 5 13/16	8 6	5 1/2	3 1/4	4 1/4
12	7 0 7/8	9 3 5/16	6	3 9/16	4 5/8
13	7 8	10 0 9/16	6 1/2	3 13/16	5
14	8 3 1/16	10 9 7/8	7	4 1/8	5 7/16
15	8 10 1/8	11 7 1/8	7 1/2	4 7/16	5 13/16
16	9 5 3/16	12 4 3/8	8	4 11/16	6 3/16
17	10 0 5/16	13 1 11/16	8 1/2	5	6 9/16
18	10 7 3/8	13 11	9	5 5/16	6 15/16
19	11 2 7/16	14 8 1/4	9 1/2	5 5/8	7 3/8
20	11 9 1/2	15 5 1/2	10	5 7/8	7 3/4
21	12 4 9/16	16 2 13/16	10 1/2	6 3/16	8 1/8
22	12 11 11/16	17 0 1/16	11	6 1/2	8 1/2
23	13 6 3/4	17 9 5/16	11 1/2	6 3/4	8 7/8
24	14 1 13/16	18 6 5/8	12	7 1/16	9 1/4
25	14 8 7/8	19 3 7/8			
26	15 3 15/16	20 1 3/16			
27	15 11 1/16	20 10 7/16			
28	16 6 1/8	21 7 3/4			
29	17 1 3/16	22 5			
30	17 8 1/4	23 2 1/4			
31	18 3 5/16	23 11 9/16			
32	18 10 7/16	24 8 13/16			
33	19 5 1/2	25 6 1/8			
34	20 0 9/16	26 3 3/8			
35	20 7 5/8	27 0 11/16			
36	21 2 11/16	27 10			
37	21 9 13/16	28 7 3/16			
38	22 4 7/8	29 4 1/2			
39	22 11 15/16	30 1 3/4			
40	23 7	30 11 1/16			
41	24 2 1/8	31 8 5/16			
42	24 9 3/16	32 5 5/8			
43	25 4 1/4	33 2 7/8			
44	25 11 5/16	34 0 1/8			
45	26 6 3/8	34 9 7/16			
46	27 1 1/2	35 6 11/16			
47	27 8 9/16	36 4			
48	28 3 5/8	37 1 1/4			
49	28 10 11/16	37 10 9/16			
50	29 5 3/4	38 7 13/16			

DIFFERENCE IN JACK RAFTER LENGTHS FOR RAFTER SPACINGS		
ON CENTER	LENGTH DIFFERENCE	
	FEET	INCHES
12"	1	2 1/8
16"	1	6 7/8
18"	1	9 1/4
20"	1	11 9/16
24"	2	4 5/16

PLUMB & SEAT CUTS FOR	
COMMON RAFTERS	
PLUMB 7 1/2	SEAT 12
HIP/VALLEY RAFTERS	
PLUMB 7 1/2	SEAT 17

RISE = 8 INCHES PER FOOT

BLDG WIDTH FEET	COMMON RAFTER FT INCHES	HIP/VALLEY RAFTER FT INCHES	ADD'L WIDTH INCHES	ADD'L COMMON LENGTH	ADDED HIP/VAL LENGTH
1	0 7 3/16	0 9 3/8	0 1/2	0 5/16	0 3/8
2	1 2 7/16	1 6 3/4	1	0 5/8	0 13/16
3	1 9 5/8	2 4 1/8	1 1/2	0 7/8	1 3/16
4	2 4 7/8	3 1 1/2	2	1 3/16	1 9/16
5	3 0 1/16	3 10 7/8	2 1/2	1 1/2	1 15/16
6	3 7 1/4	4 8 1/4	3	1 13/16	2 3/8
7	4 2 1/2	5 5 5/8	3 1/2	2 1/8	2 3/4
8	4 9 11/16	6 3	4	2 3/8	3 1/8
9	5 4 7/8	7 0 3/8	4 1/2	2 11/16	3 1/2
10	6 0 1/8	7 9 3/4	5	3	3 15/16
11	6 7 5/16	8 7 3/16	5 1/2	3 5/16	4 5/16
12	7 2 9/16	9 4 9/16	6	3 5/8	4 11/16
13	7 9 3/4	10 1 15/16	6 1/2	3 7/8	5 1/16
14	8 4 15/16	10 11 5/16	7	4 3/16	5 1/2
15	9 0 3/16	11 8 11/16	7 1/2	4 1/2	5 7/8
16	9 7 3/8	12 6 1/16	8	4 13/16	6 1/4
17	10 2 9/16	13 3 7/16	8 1/2	5 1/8	6 5/8
18	10 9 13/16	14 0 13/16	9	5 7/16	7 1/16
19	11 5	14 10 3/16	9 1/2	5 11/16	7 7/16
20	12 0 1/4	15 7 9/16	10	6	7 13/16
21	12 7 7/16	16 5	10 1/2	6 5/16	8 3/16
22	13 2 5/8	17 2 3/8	11	6 5/8	8 5/8
23	13 9 7/8	17 11 3/4	11 1/2	6 15/16	8 15/16
24	14 5 1/16	18 9 1/8	12	7 3/16	9 3/8
25	15 0 1/4	19 6 1/2	DIFFERENCE IN JACK RAFTER LENGTHS FOR RAFTER SPACINGS		
26	15 7 1/2	20 3 7/8	ON CENTER		
27	16 2 11/16	21 1 1/4			
28	16 9 15/16	21 10 5/8	FEET		
29	17 5 1/8	22 8			
30	18 0 5/16	23 5 3/8	12"	1	2 7/16
31	18 7 9/16	24 2 3/4	16"	1	7 1/4
32	19 2 3/4	25 0 1/8	18"	1	9 5/8
33	19 9 15/16	25 9 9/16	20"	2	0 1/16
34	20 5 3/16	26 6 15/16	24"	2	4 7/8
35	21 0 3/8	27 4 5/16	PLUMB & SEAT CUTS FOR		
36	21 7 5/8	28 1 11/16	COMMON RAFTERS		
37	22 2 13/16	28 11 1/16	PLUMB SEAT		
38	22 10	29 8 7/16	8 12		
39	23 5 1/4	30 5 13/16	HIP/VALLEY RAFTERS		
40	24 0 7/16	31 3 3/16	PLUMB SEAT		
41	24 7 5/8	32 0 9/16	8 17		
42	25 2 7/8	32 10			
43	25 10 1/16	33 7 3/8			
44	26 5 5/16	34 4 3/4			
45	27 0 1/2	35 2 1/8			
46	27 7 11/16	35 11 1/2			
47	28 2 15/16	36 8 7/8			
48	28 10 1/8	37 6 1/4			
49	29 5 3/8	38 3 5/8			
50	30 0 9/16	39 1			

RISE = 8.5 INCHES PER FOOT

BLDG WIDTH FEET	COMMON RAFTER FT INCHES	HIP/VALLEY RAFTER FT INCHES	ADD L WIDTH INCHES	ADD L COMMON LENGTH	ADDED HIP/VAL LENGTH
1	0 7 3/8	0 9 7/16	0 1/2	0 5/16	0 3/8
2	1 2 11/16	1 7	1	0 5/8	0 13/16
3	1 10 1/16	2 4 7/16	1 1/2	0 15/16	1 3/16
4	2 5 7/16	3 1 15/16	2	1 1/4	1 9/16
5	3 0 3/4	3 11 7/16	2 1/2	1 9/16	1 15/16
6	3 8 1/8	4 8 15/16	3	1 13/16	2 3/8
7	4 3 1/2	5 6 3/8	3 1/2	2 1/8	2 3/4
8	4 10 13/16	6 3 7/8	4	2 7/16	3 3/16
9	5 6 3/16	7 1 3/8	4 1/2	2 3/4	3 9/16
10	6 1 1/2	7 10 7/8	5	3 1/16	3 15/16
11	6 8 7/8	8 8 3/8	5 1/2	3 3/8	4 3/8
12	7 4 1/4	9 5 7/8	6	3 11/16	4 3/4
13	7 11 9/16	10 3 5/16	6 1/2	3 15/16	5 1/8
14	8 6 15/16	11 0 13/16	7	4 5/16	5 9/16
15	9 2 5/16	11 10 5/16	7 1/2	4 5/8	5 15/16
16	9 9 5/8	12 7 13/16	8	4 7/8	6 5/16
17	10 5	13 5 5/16	8 1/2	5 3/16	6 3/4
18	11 0 3/8	14 2 13/16	9	5 1/2	7 1/8
19	11 7 11/16	15 0 1/4	9 1/2	5 13/16	7 1/2
20	12 3 1/16	15 9 3/4	10	6 1/8	7 15/16
21	12 10 7/16	16 7 1/4	10 1/2	6 7/16	8 5/16
22	13 5 3/4	17 4 3/4	11	6 3/4	8 11/16
23	14 1 1/8	18 2 1/4	11 1/2	7 1/16	9 1/8
24	14 8 7/16	18 11 3/4	12	7 3/8	9 1/2
25	15 3 13/16	19 9 1/4			
26	15 11 3/16	20 6 11/16	DIFFERENCE IN JACK RAFTER LENGTHS FOR RAFTER SPACINGS		
27	16 6 1/2	21 4 3/16			
28	17 1 7/8	22 1 11/16			
29	17 9 1/4	22 11 3/16			
30	18 4 9/16	23 8 11/16	ON CENTER	LENGTH DIFFERENCE	
31	18 11 15/16	24 6 3/16		FEET	INCHES
32	19 7 5/16	25 3 5/8	12"	1	2 11/16
33	20 2 5/8	26 1 1/8	16"	1	7 5/8
34	20 10	26 10 5/8	18"	1	10 1/16
35	21 5 3/8	27 8 1/8	20"	2	0 1/2
36	22 0 11/16	28 5 5/8	24"	2	5 7/16
37	22 8 1/16	29 3 1/8			
38	23 3 3/8	30 0 9/16	PLUMB & SEAT CUTS FOR		
39	23 10 3/4	30 10 1/16	COMMON RAFTERS		
40	24 6 1/8	31 7 9/16	PLUMB	SEAT	
41	25 1 7/16	32 5 1/16	8 1/2	12	
42	25 8 13/16	33 2 9/16	HIP/VALLEY RAFTERS		
43	26 4 3/16	34 0 1/16	PLUMB	SEAT	
44	26 11 1/2	34 9 9/16	8 1/2	17	
45	27 6 7/8	35 7			
46	28 2 1/4	36 4 1/2			
47	28 9 9/16	37 2			
48	29 4 15/16	37 11 1/2			
49	30 0 5/16	38 9			
50	30 7 5/8	39 6 1/2			

RISE = 9 INCHES PER FOOT

BLDG WIDTH FEET	COMMON RAFTER FT INCHES	HIP/VALLEY RAFTER FT INCHES	ADD'L WIDTH INCHES	ADD'L COMMON LENGTH	ADDED HIP/VAL LENGTH
1	0 7 1/2	0 9 9/16	0 1/2	0 5/16	0 3/8
2	1 3	1 7 3/16	1	0 5/8	0 13/16
3	1 10 1/2	2 4 13/16	1 1/2	0 15/16	1 3/16
4	2 6	3 2 3/8	2	1 1/4	1 5/8
5	3 1 1/2	4 0	2 1/2	1 9/16	2
6	3 9	4 9 5/8	3	1 7/8	2 3/8
7	4 4 1/2	5 7 3/16	3 1/2	2 3/16	2 13/16
8	5 0	6 4 13/16	4	2 1/2	3 3/16
9	5 7 1/2	7 2 7/16	4 1/2	2 13/16	3 5/8
10	6 3	8 0	5	3 1/8	4
11	6 10 1/2	8 9 5/8	5 1/2	3 7/16	4 3/8
12	7 6	9 7 1/4	6	3 3/4	4 13/16
13	8 1 1/2	10 4 13/16	6 1/2	4 1/16	5 3/16
14	8 9	11 2 7/16	7	4 3/8	5 5/8
15	9 4 1/2	12 0 1/16	7 1/2	4 11/16	6
16	10 0	12 9 5/8	8	5	6 3/8
17	10 7 1/2	13 7 1/4	8 1/2	5 5/16	6 13/16
18	11 3	14 4 7/8	9	5 5/8	7 3/16
19	11 10 1/2	15 2 7/16	9 1/2	5 15/16	7 5/8
20	12 6	16 0 1/16	10	6 1/4	8
21	13 1 1/2	16 9 11/16	10 1/2	6 9/16	8 3/8
22	13 9	17 7 1/4	11	6 7/8	8 13/16
23	14 4 1/2	18 4 7/8	11 1/2	7 3/16	9 3/16
24	15 0	19 2 1/2	12	7 1/2	9 5/8
25	15 7 1/2	20 0 1/16			
26	16 3	20 9 11/16			
27	16 10 1/2	21 7 5/16			
28	17 6	22 4 7/8			
29	18 1 1/2	23 2 1/2			
30	18 9	24 0 1/8			
31	19 4 1/2	24 9 11/16			
32	20 0	25 7 5/16			
33	20 7 1/2	26 4 15/16			
34	21 3	27 2 1/2			
35	21 10 1/2	28 0 1/8			
36	22 6	28 9 3/4			
37	23 1 1/2	29 7 5/16			
38	23 9	30 5			
39	24 4 1/2	31 2 9/16			
40	25 0	32 0 1/8			
41	25 7 1/2	32 9 3/4			
42	26 3	33 7 3/8			
43	26 10 1/2	34 5			
44	27 6	35 2 9/16			
45	28 1 1/2	36 0 3/16			
46	28 9	36 9 13/16			
47	29 4 1/2	37 7 3/8			
48	30 0	38 5			
49	30 7 1/2	39 2 5/8			
50	31 3	40 0 3/16			

DIFFERENCE IN JACK RAFTER LENGTHS FOR RAFTER SPACINGS		
ON CENTER	LENGTH DIFFERENCE	
	FEET	INCHES
12"	1	3
16"	1	8
18"	1	10 1/2
20"	2	1
24"	2	6

PLUMB & SEAT CUTS FOR	
COMMON RAFTERS	
PLUMB	SEAT
9	12
HIP/VALLEY RAFTERS	
PLUMB	SEAT
9	17

RISE = 9.5 INCHES PER FOOT

BLDG WIDTH FEET	COMMON RAFTER FT INCHES	HIP/VALLEY RAFTER FT INCHES	ADD'L WIDTH INCHES	ADD'L COMMON LENGTH	ADDED HIP/VAL LENGTH
1	0 7 5/8	0 9 11/16	0 1/2	0 5/16	0 3/8
2	1 3 5/16	1 7 7/16	1	0 5/8	0 13/16
3	1 10 15/16	2 5 1/8	1 1/2	0 15/16	1 3/16
4	2 6 5/8	3 2 7/8	2	1 1/4	1 5/8
5	3 2 1/4	4 0 9/16	2 1/2	1 5/8	2
6	3 9 15/16	4 10 5/16	3	1 15/16	2 7/16
7	4 5 9/16	5 8 1/16	3 1/2	2 1/4	2 13/16
8	5 1 1/4	6 5 3/4	4	2 9/16	3 1/4
9	5 8 7/8	7 3 1/2	4 1/2	2 7/8	3 5/8
10	6 4 1/2	8 1 3/16	5	3 3/16	4 1/16
11	7 0 3/16	8 10 15/16	5 1/2	3 1/2	4 7/16
12	7 7 13/16	9 8 11/16	6	3 13/16	4 7/8
13	8 3 1/2	10 6 3/8	6 1/2	4 1/8	5 1/4
14	8 11 1/8	11 4 1/8	7	4 7/16	5 11/16
15	9 6 13/16	12 1 13/16	7 1/2	4 13/16	6 1/16
16	10 2 7/16	12 11 9/16	8	5 1/8	6 1/2
17	10 10 1/8	13 9 5/16	8 1/2	5 7/16	6 7/8
18	11 5 3/4	14 7	9	5 3/4	7 5/16
19	12 1 3/8	15 4 3/4	9 1/2	6 1/16	7 11/16
20	12 9 1/16	16 2 7/16	10	6 3/8	8 1/8
21	13 4 11/16	17 0 3/16	10 1/2	6 11/16	8 1/2
22	14 0 3/8	17 9 7/8	11	7	8 15/16
23	14 8	18 7 5/8	11 1/2	7 5/16	9 5/16
24	15 3 11/16	19 5 3/8	12	7 5/8	9 3/4
25	15 11 5/16	20 3 1/16			
26	16 6 15/16	21 0 13/16			
27	17 2 5/8	21 10 1/2			
28	17 10 1/4	22 8 1/4			
29	18 5 15/16	23 6			
30	19 1 9/16	24 3 11/16			
31	19 9 1/4	25 1 7/16			
32	20 4 7/8	25 11 1/8			
33	21 0 9/16	26 8 7/8			
34	21 8 3/16	27 6 5/8			
35	22 3 13/16	28 4 5/16			
36	22 11 1/2	29 2 1/16			
37	23 7 1/8	29 11 3/4			
38	24 2 13/16	30 9 1/2			
39	24 10 7/16	31 7 3/16			
40	25 6 1/8	32 5			
41	26 1 3/4	33 2 11/16			
42	26 9 7/16	34 0 3/8			
43	27 5 1/16	34 10 1/8			
44	28 0 11/16	35 7 13/16			
45	28 8 3/8	36 5 9/16			
46	29 4	37 3 5/16			
47	29 11 11/16	38 1			
48	30 7 5/16	38 10 3/4			
49	31 3	39 8 7/16			
50	31 10 5/8	40 6 3/16			

DIFFERENCE IN JACK RAFTER LENGTHS FOR RAFTER SPACINGS		
	ON CENTER	LENGTH DIFFERENCE
		FEET INCHES
	12"	1 3 5/16
	16"	1 8 7/16
	18"	1 10 15/16
	20"	2 1 1/2
	24"	2 6 5/8

PLUMB & SEAT CUTS FOR	
COMMON RAFTERS	
PLUMB	SEAT
9 1/2	12
HIP/VALLEY RAFTERS	
PLUMB	SEAT
9 1/2	17

RISE = 10 INCHES PER FOOT

BLDG WIDTH FEET	COMMON RAFTER FT INCHES	HIP/VALLEY RAFTER FT INCHES	ADD'L WIDTH INCHES	ADD'L COMMON LENGTH	ADDED HIP/VAL LENGTH
1	0 7 13/16	0 9 13/16	0 1/2	0 5/16	0 7/16
2	1 3 5/8	1 7 11/16	1	0 5/8	0 13/16
3	1 11 7/16	2 5 1/2	1 1/2	0 15/16	1 1/4
4	2 7 1/4	3 3 3/8	2	1 5/16	1 5/8
5	3 3 1/16	4 1 3/16	2 1/2	1 5/8	2 1/16
6	3 10 7/8	4 11 1/16	3	1 15/16	2 7/16
7	4 6 11/16	5 8 15/16	3 1/2	2 1/4	2 7/8
8	5 2 1/2	6 6 3/4	4	2 5/8	3 5/16
9	5 10 5/16	7 4 5/8	4 1/2	2 15/16	3 11/16
10	6 6 1/8	8 2 7/16	5	3 1/4	4 1/8
11	7 1 15/16	9 0 5/16	5 1/2	3 9/16	4 1/2
12	7 9 3/4	9 10 1/8	6	3 7/8	4 15/16
13	8 5 9/16	10 8	6 1/2	4 1/4	5 5/16
14	9 1 5/16	11 5 7/8	7	4 9/16	5 3/4
15	9 9 1/8	12 3 11/16	7 1/2	4 7/8	6 1/8
16	10 4 15/16	13 1 9/16	8	5 3/16	6 9/16
17	11 0 3/4	13 11 3/8	8 1/2	5 9/16	6 15/16
18	11 8 9/16	14 9 1/4	9	5 7/8	7 3/8
19	12 4 3/8	15 7 1/8	9 1/2	6 3/16	7 13/16
20	13 0 3/16	16 5	10	6 1/2	8 3/16
21	13 8	17 2 13/16	10 1/2	6 13/16	8 5/8
22	14 3 13/16	18 0 5/8	11	7 3/16	9
23	14 11 5/8	18 10 1/2	11 1/2	7 1/2	9 7/16
24	15 7 7/16	19 8 5/16	12	7 13/16	9 7/8
25	16 3 1/4	20 6 3/16			
26	16 11 1/16	21 4 1/16	DIFFERENCE IN JACK RAFTER LENGTHS FOR RAFTER SPACINGS		
27	17 6 7/8	22 1 7/8	ON CENTER	LENGTH DIFFERENCE	
28	18 2 11/16	22 11 3/4		FEET	INCHES
29	18 10 1/2	23 9 9/16	12"	1	3 5/8
30	19 6 5/16	24 7 7/16	16"	1	8 13/16
31	20 2 1/8	25 5 5/16	18"	1	11 7/16
32	20 9 15/16	26 3 1/8	20"	2	2 1/16
33	21 5 3/4	27 1	24"	2	7 1/4
34	22 1 9/16	27 10 13/16			
35	22 9 3/8	28 8 11/16	PLUMB & SEAT CUTS FOR		
36	23 5 3/16	29 6 1/2	COMMON RAFTERS		
37	24 1	30 4 3/8	PLUMB	SEAT	
38	24 8 13/16	31 2 1/4	10	12	
39	25 4 5/8	32 0 1/16	HIP/VALLEY RAFTERS		
40	26 0 7/16	32 9 15/16	PLUMB	SEAT	
41	26 8 1/4	33 7 3/4	10	17	
42	27 4	34 5 5/8			
43	27 11 13/16	35 3 1/2			
44	28 7 5/8	36 1 5/16			
45	29 3 7/16	36 11 3/16			
46	29 11 1/4	37 9			
47	30 7 1/16	38 6 7/8			
48	31 2 7/8	39 4 11/16			
49	31 10 11/16	40 2 9/16			
50	32 6 1/2	41 0 7/16			

RISE = 10.5 INCHES PER FOOT

BLDG WIDTH FEET	COMMON RAFTER FT INCHES	HIP/VALLEY RAFTER FT INCHES	ADD'L WIDTH INCHES	ADD'L COMMON LENGTH	ADDED HIP/VAL LENGTH
1	0 8	0 10	0 1/2	0 5/16	0 7/16
2	1 3 15/16	1 7 15/16	1	0 11/16	0 13/16
3	1 11 15/16	2 5 7/8	1 1/2	0 15/16	1 1/4
4	2 7 7/8	3 3 7/8	2	1 5/16	1 11/16
5	3 3 7/8	4 1 7/8	2 1/2	1 11/16	2 1/16
6	3 11 13/16	4 11 13/16	3	1 15/16	2 1/2
7	4 7 13/16	5 9 13/16	3 1/2	2 5/16	2 15/16
8	5 3 3/4	6 7 13/16	4	2 11/16	3 5/16
9	5 11 3/4	7 5 3/4	4 1/2	2 15/16	3 3/4
10	6 7 3/4	8 3 3/4	5	3 5/16	4 3/16
11	7 3 11/16	9 1 3/4	5 1/2	3 5/8	4 9/16
12	7 11 11/16	9 11 11/16	6	3 15/16	4 15/16
13	8 7 5/8	10 9 11/16	6 1/2	4 5/16	5 3/8
14	9 3 5/8	11 7 11/16	7	4 5/8	5 13/16
15	9 11 9/16	12 5 5/8	7 1/2	4 15/16	6 1/4
16	10 7 9/16	13 3 5/8	8	5 5/16	6 5/8
17	11 3 9/16	14 1 5/8	8 1/2	5 5/8	7 1/16
18	11 11 1/2	14 11 9/16	9	5 15/16	7 1/2
19	12 7 1/2	15 9 9/16	9 1/2	6 5/16	7 7/8
20	13 3 7/16	16 7 1/2	10	6 5/8	8 5/16
21	13 11 7/16	17 5 1/2	10 1/2	6 15/16	8 3/4
22	14 7 3/8	18 3 1/2	11	7 5/16	9 1/8
23	15 3 3/8	19 1 7/16	11 1/2	7 5/8	9 9/16
24	15 11 5/16	19 11 7/16	12	7 15/16	9 15/16
25	16 7 5/16	20 9 7/16	DIFFERENCE IN JACK RAFTER LENGTHS FOR RAFTER SPACINGS		
26	17 3 5/16	21 7 3/8	ON CENTER LENGTH DIFFERENCE		
27	17 11 1/4	22 5 3/8			
28	18 7 1/4	23 3 3/8	FEET INCHES		
29	19 3 3/16	24 1 5/16			
30	19 11 3/16	24 11 5/16			
31	20 7 1/8	25 9 5/16			
32	21 3 1/8	26 7 1/4			
33	21 11 1/8	27 5 1/4			
34	22 7 1/16	28 3 1/4	12"	1	3 15/16
35	23 3 1/16	29 1 3/16	16"	1	9 1/4
36	23 11	29 11 3/16	18"	1	11 15/16
37	24 7	30 9 3/16	20"	2	2 9/16
38	25 2 15/16	31 7 1/8	24"	2	7 7/8
39	25 10 15/16	32 5 1/8	PLUMB & SEAT CUTS FOR		
40	26 6 7/8	33 3 1/16	COMMON RAFTERS		
41	27 2 7/8	34 1 1/16	PLUMB SEAT		
42	27 10 7/8	34 11 1/16	10 1/2 12		
43	28 6 13/16	35 9	HIP/VALLEY RAFTERS		
44	29 2 13/16	36 7	PLUMB SEAT		
45	29 10 3/4	37 5	10 1/2 17		
46	30 6 3/4	38 3			
47	31 2 11/16	39 1			
48	31 10 11/16	39 10 15/16			
49	32 6 11/16	40 8 7/8			
50	33 2 5/8	41 6 7/8			

RISE = 11 INCHES PER FOOT

BLDG WIDTH FEET	COMMON RAFTER FT INCHES	HIP/VALLEY RAFTER FT INCHES	ADD'L WIDTH INCHES	ADD'L COMMON LENGTH	ADDED HIP/VAL LENGTH
1	0 8 1/8	0 10 1/16	0 1/2	0 5/16	0 7/16
2	1 4 1/4	1 8 3/16	1	0 11/16	0 13/16
3	2 0 7/16	2 6 5/16	1 1/2	1	1 1/4
4	2 8 9/16	3 4 7/16	2	1 3/8	1 11/16
5	3 4 11/16	4 2 1/2	2 1/2	1 11/16	2 1/8
6	4 0 13/16	5 0 5/8	3	2 1/16	2 1/2
7	4 9	5 10 3/4	3 1/2	2 3/8	2 15/16
8	5 5 1/8	6 8 7/8	4	2 11/16	3 3/8
9	6 1 1/4	7 7	4 1/2	3 1/16	3 13/16
10	6 9 3/8	8 5 1/16	5	3 3/8	4 3/16
11	7 5 9/16	9 3 3/16	5 1/2	3 3/4	4 5/8
12	8 1 11/16	10 1 5/16	6	4 1/16	5 1/16
13	8 9 13/16	10 11 7/16	6 1/2	4 7/16	5 1/2
14	9 5 15/16	11 9 9/16	7	4 3/4	5 7/8
15	10 2 1/16	12 7 5/8	7 1/2	5 1/16	6 5/16
16	10 10 1/4	13 5 3/4	8	5 7/16	6 3/4
17	11 6 3/8	14 3 7/8	8 1/2	5 3/4	7 3/16
18	12 2 1/2	15 2	9	6 1/8	7 9/16
19	12 10 5/8	16 0 1/8	9 1/2	6 7/16	8
20	13 6 13/16	16 10 3/16	10	6 13/16	8 7/16
21	14 2 15/16	17 8 5/16	10 1/2	7 1/8	8 7/8
22	14 11 1/16	18 6 7/16	11	7 7/16	9 1/4
23	15 7 3/16	19 4 9/16	11 1/2	7 13/16	9 11/16
24	16 3 3/8	20 2 5/8	12	8 1/8	10 1/8
25	16 11 1/2	21 0 3/4			
26	17 7 5/8	21 10 7/8			
27	18 3 3/4	22 9			
28	18 11 7/8	23 7 1/8			
29	19 8 1/16	24 5 3/16			
30	20 4 3/16	25 3 5/16			
31	21 0 5/16	26 1 7/16			
32	21 8 7/16	26 11 9/16			
33	22 4 5/8	27 9 11/16			
34	23 0 3/4	28 7 3/4			
35	23 8 7/8	29 5 7/8			
36	24 5	30 4			
37	25 1 3/16	31 2 1/8			
38	25 9 5/16	32 0 1/4			
39	26 5 7/16	32 10 5/16			
40	27 1 9/16	33 8 7/16			
41	27 9 11/16	34 6 9/16			
42	28 5 7/8	35 4 11/16			
43	29 2	36 2 3/4			
44	29 10 1/8	37 0 7/8			
45	30 6 1/4	37 11			
46	31 2 7/16	38 9 1/8			
47	31 10 9/16	39 7 1/4			
48	32 6 11/16	40 5 5/16			
49	33 2 13/16	41 3 7/16			
50	33 11	42 1 9/16			

DIFFERENCE IN JACK RAFTER LENGTHS FOR RAFTER SPACINGS		
ON CENTER	LENGTH DIFFERENCE	
	FEET	INCHES
12"	1	4 1/4
16"	1	9 11/16
18"	2	0 7/16
20"	2	3 1/8
24"	2	8 9/16

PLUMB & SEAT CUTS FOR	
COMMON RAFTERS	
PLUMB 11	SEAT 12
HIP/VALLEY RAFTERS	
PLUMB 11	SEAT 17

RISE = 11.5 INCHES PER FOOT

BLDG WIDTH FEET	COMMON RAFTER FT INCHES	HIP/VALLEY RAFTER FT INCHES	ADD'L WIDTH INCHES	ADD'L COMMON LENGTH	ADDED HIP/VAL LENGTH						
1	0 8 5/16	0 10 3/16	0 1/2	0 3/8	0 7/16						
2	1 4 5/8	1 8 7/16	1	0 11/16	0 7/8						
3	2 0 15/16	2 6 3/4	1 1/2	1 1/16	1 5/16						
4	2 9 1/4	3 5	2	1 3/8	1 11/16						
5	3 5 9/16	4 3 3/16	2 1/2	1 3/4	2 1/8						
6	4 1 7/8	5 1 1/2	3	2 1/16	2 9/16						
7	4 10 3/16	5 11 3/4	3 1/2	2 7/16	2 15/16						
8	5 6 1/2	6 10	4	2 3/4	3 7/16						
9	6 2 13/16	7 8 1/4	4 1/2	3 1/8	3 7/8						
10	6 11 1/8	8 6 7/16	5	3 7/16	4 1/4						
11	7 7 7/16	9 4 3/4	5 1/2	3 13/16	4 11/16						
12	8 3 3/4	10 3	6	4 1/8	5 1/8						
13	9 0 1/16	11 1 3/16	6 1/2	4 1/2	5 9/16						
14	9 8 3/8	11 11 1/2	7	4 7/8	5 15/16						
15	10 4 5/8	12 9 3/4	7 1/2	5 3/16	6 7/16						
16	11 0 15/16	13 8	8	5 9/16	6 13/16						
17	11 9 1/4	14 6 1/4	8 1/2	5 7/8	7 1/4						
18	12 5 9/16	15 4 1/2	9	6 1/4	7 11/16						
19	13 1 7/8	16 2 3/4	9 1/2	6 9/16	8 1/8						
20	13 10 3/16	17 1	10	6 15/16	8 9/16						
21	14 6 1/2	17 11 1/4	10 1/2	7 1/4	8 15/16						
22	15 2 13/16	18 9 1/2	11	7 5/8	9 3/8						
23	15 11 1/8	19 7 11/16	11 1/2	7 15/16	9 13/16						
24	16 7 7/16	20 6	12	8 5/16	10 1/4						
25	17 3 3/4	21 4 1/4	DIFFERENCE IN JACK RAFTER LENGTHS FOR RAFTER SPACINGS								
26	18 0 1/16	22 2 7/16	ON CENTER LENGTH DIFFERENCE								
27	18 8 3/8	23 0 3/4									
28	19 4 11/16	23 11	FEET INCHES								
29	20 1	24 9 3/16									
30	20 9 5/16	25 7 1/2	PLUMB & SEAT CUTS FOR								
31	21 5 5/8	26 5 3/4									
32	22 1 15/16	27 4				COMMON RAFTERS					
33	22 10 1/4	28 2 1/4							PLUMB SEAT 11 1/2 12		
34	23 6 9/16	29 0 1/2									
35	24 2 7/8	29 10 11/16									
36	24 11 3/16	30 9									
37	25 7 1/2	31 7 1/4	HIP/VALLEY RAFTERS								
38	26 3 13/16	32 5 1/2				PLUMB SEAT 11 1/2 17					
39	27 0 1/8	33 3 3/4									
40	27 8 7/16	34 2									
41	28 4 3/4	35 0 1/4									
42	29 1 1/16	35 10 1/2									
43	29 9 3/8	36 8 11/16	COMMON RAFTERS								
44	30 5 11/16	37 7				PLUMB SEAT 11 1/2 12					
45	31 1 15/16	38 5 1/4									
46	31 10 1/4	39 3 7/16									
47	32 6 9/16	40 1 3/4									
48	33 2 7/8	41 0									
49	33 11 3/16	41 10 3/16									
50	34 7 1/2	42 8 1/2									

RISE = 12 INCHES PER FOOT

BLDG WIDTH FEET	COMMON RAFTER FT INCHES	HIP/VALLEY RAFTER FT INCHES	ADD'L WIDTH INCHES	ADD'L COMMON LENGTH	ADDED HIP/VAL LENGTH																					
1	0 8 1/2	0 10 3/8	0 1/2	0 3/8	0 7/16																					
2	1 5	1 8 3/4	1	0 11/16	0 7/8																					
3	2 1 7/16	2 7 1/8	1 1/2	1 1/16	1 5/16																					
4	2 9 15/16	3 5 9/16	2	1 7/16	1 3/4																					
5	3 6 7/16	4 3 15/16	2 1/2	1 3/4	2 3/16																					
6	4 2 15/16	5 2 5/16	3	2 1/8	2 5/8																					
7	4 11 3/8	6 0 11/16	3 1/2	2 1/2	3																					
8	5 7 7/8	6 11 1/8	4	2 13/16	3 7/16																					
9	6 4 3/8	7 9 1/2	4 1/2	3 3/16	3 7/8																					
10	7 0 7/8	8 7 7/8	5	3 9/16	4 5/16																					
11	7 9 5/16	9 6 5/16	5 1/2	3 7/8	4 3/4																					
12	8 5 13/16	10 4 11/16	6	4 1/4	5 3/16																					
13	9 2 5/16	11 3 1/16	6 1/2	4 5/8	5 5/8																					
14	9 10 13/16	12 1 7/16	7	4 15/16	6 1/16																					
15	10 7 1/4	12 11 7/8	7 1/2	5 5/16	6 1/2																					
16	11 3 3/4	13 10 1/4	8	5 11/16	6 15/16																					
17	12 0 1/4	14 8 5/8	8 1/2	6	7 3/8																					
18	12 8 3/4	15 7	9	6 3/8	7 13/16																					
19	13 5 1/4	16 5 7/16	9 1/2	6 11/16	8 1/4																					
20	14 1 11/16	17 3 13/16	10	7 1/16	8 11/16																					
21	14 10 3/16	18 2 3/16	10 1/2	7 7/16	9 1/16																					
22	15 6 11/16	19 0 5/8	11	7 3/4	9 1/2																					
23	16 3 3/16	19 11	11 1/2	8 1/8	9 15/16																					
24	16 11 5/8	20 9 3/8	12	8 1/2	10 3/8																					
25	17 8 1/8	21 7 3/4	DIFFERENCE IN JACK RAFTER LENGTHS FOR RAFTER SPACINGS																							
26	18 4 5/8	22 6 3/16	<table border="1" style="width: 100%; border-collapse: collapse;"> <thead> <tr> <th style="width: 20%;">ON CENTER</th> <th colspan="2">LENGTH DIFFERENCE</th> </tr> <tr> <td></td> <th style="width: 30%;">FEET</th> <th style="width: 30%;">INCHES</th> </tr> </thead> <tbody> <tr><td>12"</td><td>1</td><td>5</td></tr> <tr><td>16"</td><td>1</td><td>10 5/8</td></tr> <tr><td>18"</td><td>2</td><td>1 7/16</td></tr> <tr><td>20"</td><td>2</td><td>4 5/16</td></tr> <tr><td>24"</td><td>2</td><td>9 15/16</td></tr> </tbody> </table>			ON CENTER	LENGTH DIFFERENCE			FEET	INCHES	12"	1	5	16"	1	10 5/8	18"	2	1 7/16	20"	2	4 5/16	24"	2	9 15/16
ON CENTER	LENGTH DIFFERENCE																									
	FEET	INCHES																								
12"	1	5																								
16"	1	10 5/8																								
18"	2	1 7/16																								
20"	2	4 5/16																								
24"	2	9 15/16																								
27	19 1 1/8	23 4 9/16																								
28	19 9 9/16	24 3																								
29	20 6 1/16	25 1 3/8																								
30	21 2 9/16	25 11 3/4																								
31	21 11 1/16	26 10 1/8																								
32	22 7 1/2	27 8 1/2																								
33	23 4	28 6 15/16																								
34	24 0 1/2	29 5 5/16																								
35	24 9	30 3 11/16																								
36	25 5 1/2	31 2 1/16																								
37	26 1 15/16	32 0 1/2																								
38	26 10 7/16	32 10 7/8																								
39	27 6 15/16	33 9 1/4	PLUMB & SEAT CUTS FOR																							
40	28 3 7/16	34 7 11/16	COMMON RAFTERS																							
41	28 11 7/8	35 6 1/16	<table style="width: 100%; border: none;"> <tr> <td style="width: 50%;">PLUMB</td> <td style="width: 50%;">SEAT</td> </tr> <tr> <td style="text-align: center;">12</td> <td style="text-align: center;">12</td> </tr> </table>			PLUMB	SEAT	12	12																	
PLUMB	SEAT																									
12	12																									
42	29 8 3/8	36 4 7/16	HIP/VALLEY RAFTERS																							
43	30 4 7/8	37 2 13/16	<table style="width: 100%; border: none;"> <tr> <td style="width: 50%;">PLUMB</td> <td style="width: 50%;">SEAT</td> </tr> <tr> <td style="text-align: center;">12</td> <td style="text-align: center;">17</td> </tr> </table>			PLUMB	SEAT	12	17																	
PLUMB	SEAT																									
12	17																									
44	31 1 3/8	38 1 1/4																								
45	31 9 13/16	38 11 5/8																								
46	32 6 5/16	39 10																								
47	33 2 13/16	40 8 7/16																								
48	33 11 5/16	41 6 13/16																								
49	34 7 3/4	42 5 3/16																								
50	35 4 1/4	43 3 9/16																								

RISE = 12.5 INCHES PER FOOT

BLDG WIDTH FEET	COMMON RAFTER FT INCHES	HIP/VALLEY RAFTER FT INCHES	ADD'L WIDTH INCHES	ADD'L COMMON LENGTH	ADDED HIP/VAL LENGTH
1	0 8 11/16	0 10 1/2	0 1/2	0 3/8	0 7/16
2	1 5 5/16	1 9 1/16	1	0 3/4	0 7/8
3	2 2	2 7 9/16	1 1/2	1 1/16	1 5/16
4	2 10 5/8	3 6 1/8	2	1 7/16	1 3/4
5	3 7 5/16	4 4 11/16	2 1/2	1 13/16	2 3/16
6	4 4	5 3 3/16	3	2 3/16	2 5/8
7	5 0 5/8	6 1 3/4	3 1/2	2 1/2	3 1/16
8	5 9 5/16	7 0 1/4	4	2 7/8	3 1/2
9	6 6	7 10 13/16	4 1/2	3 1/4	3 15/16
10	7 2 5/8	8 9 3/8	5	3 5/8	4 3/8
11	7 11 5/16	9 7 7/8	5 1/2	3 15/16	4 13/16
12	8 7 15/16	10 6 7/16	6	4 5/16	5 1/4
13	9 4 5/8	11 5	6 1/2	4 11/16	5 11/16
14	10 1 5/16	12 3 1/2	7	5 1/16	6 1/8
15	10 9 15/16	13 2 1/16	7 1/2	5 7/16	6 9/16
16	11 6 5/8	14 0 9/16	8	5 3/4	7
17	12 3 5/16	14 11 1/8	8 1/2	6 1/8	7 7/16
18	12 11 15/16	15 9 11/16	9	6 1/2	7 7/8
19	13 8 5/8	16 8 3/16	9 1/2	6 7/8	8 5/16
20	14 5 1/4	17 6 3/4	10	7 1/4	8 13/16
21	15 1 15/16	18 5 1/4	10 1/2	7 9/16	9 1/4
22	15 10 5/8	19 3 13/16	11	7 15/16	9 11/16
23	16 7 1/4	20 2 3/8	11 1/2	8 5/16	10 1/8
24	17 3 15/16	21 0 7/8	12	8 11/16	10 9/16
25	18 0 5/8	21 11 7/16	DIFFERENCE IN JACK RAFTER LENGTHS FOR RAFTER SPACINGS		
26	18 9 1/4	22 10	ON CENTER LENGTH DIFFERENCE		
27	19 5 15/16	23 8 1/2	12" 16" 18" 20" 24"	FEET	INCHES
28	20 2 9/16	24 7 1/16		1	5 5/16
29	20 11 1/4	25 5 9/16		1	11 1/8
30	21 7 15/16	26 4 1/8		2	1 15/16
31	22 4 9/16	27 2 11/16		2	4 7/8
32	23 1 1/4	28 1 3/16		2	10 5/8
33	23 9 15/16	28 11 3/4	PLUMB & SEAT CUTS FOR		
34	24 6 9/16	29 10 5/16	COMMON RAFTERS		
35	25 3 1/4	30 8 13/16	PLUMB	SEAT	
36	25 11 7/8	31 7 3/8	12 1/2	12	
37	26 8 9/16	32 5 7/8	HIP/VALLEY RAFTERS		
38	27 5 1/4	33 4 7/16	PLUMB	SEAT	
39	28 1 7/8	34 3	12 1/2	17	
40	28 10 9/16	35 1 1/2			
41	29 7 3/16	36 0 1/16			
42	30 3 7/8	36 10 9/16			
43	31 0 9/16	37 9 1/8			
44	31 9 3/16	38 7 11/16			
45	32 5 7/8	39 6 3/16			
46	33 2 9/16	40 4 3/4			
47	33 11 3/16	41 3 5/16			
48	34 7 7/8	42 1 13/16			
49	35 4 1/2	43 0 3/8			
50	36 1 3/16	43 10 7/8			

RISE = 13 INCHES PER FOOT

BLDG WIDTH FEET	COMMON RAFTER FT INCHES	HIP/VALLEY RAFTER FT INCHES	ADD'L WIDTH INCHES	ADD'L COMMON LENGTH	ADDED HIP/VAL LENGTH
1	0 8 7/8	0 10 11/16	0 1/2	0 3/8	0 7/16
2	1 5 11/16	1 9 3/8	1	0 3/4	0 7/8
3	2 2 9/16	2 8 1/16	1 1/2	1 1/8	1 5/16
4	2 11 3/8	3 6 3/4	2	1 1/2	1 13/16
5	3 8 1/4	4 5 7/16	2 1/2	1 13/16	2 1/4
6	4 5 1/16	5 4 1/8	3	2 3/16	2 11/16
7	5 1 15/16	6 2 13/16	3 1/2	2 9/16	3 1/8
8	5 10 3/4	7 1 1/2	4	2 15/16	3 9/16
9	6 7 5/8	8 0 3/16	4 1/2	3 5/16	4
10	7 4 7/16	8 10 7/8	5	3 11/16	4 7/16
11	8 1 5/16	9 9 9/16	5 1/2	4 1/16	4 7/8
12	8 10 1/8	10 8 1/4	6	4 7/16	5 3/8
13	9 7	11 6 15/16	6 1/2	4 13/16	5 13/16
14	10 3 13/16	12 5 5/8	7	5 3/16	6 1/4
15	11 0 11/16	13 4 5/16	7 1/2	5 1/2	6 11/16
16	11 9 9/16	14 3	8	5 7/8	7 1/8
17	12 6 3/8	15 1 11/16	8 1/2	6 1/4	7 9/16
18	13 3 1/4	16 0 3/8	9	6 5/8	8
19	14 0 1/16	16 11 1/16	9 1/2	7	8 7/16
20	14 8 15/16	17 9 3/4	10	7 3/8	8 15/16
21	15 5 3/4	18 8 7/16	10 1/2	7 3/4	9 3/8
22	16 2 5/8	19 7 1/8	11	8 1/8	9 13/16
23	16 11 7/16	20 5 13/16	11 1/2	8 1/2	10 1/4
24	17 8 5/16	21 4 1/2	12	8 7/8	10 11/16
25	18 5 1/8	22 3 3/16	DIFFERENCE IN JACK RAFTER LENGTHS FOR RAFTER SPACINGS		
26	19 2	23 1 7/8	ON CENTER		
27	19 10 13/16	24 0 9/16			
28	20 7 11/16	24 11 1/4	LENGTH DIFFERENCE		
29	21 4 1/2	25 10	FEET INCHES		
30	22 1 3/8	26 8 5/8			
31	22 10 1/4	27 7 5/16			
32	23 7 1/16	28 6			
33	24 3 15/16	29 4 11/16			
34	25 0 3/4	30 3 3/8	12"	1	5 11/16
35	25 9 5/8	31 2 1/16	16"	1	11 9/16
36	26 6 7/16	32 0 3/4	18"	2	2 9/16
37	27 3 5/16	32 11 7/16	20"	2	5 1/2
38	28 0 1/8	33 10 1/8	24"	2	11 3/8
39	28 9	34 8 13/16	PLUMB & SEAT CUTS FOR		
40	29 5 13/16	35 7 1/2	COMMON RAFTERS		
41	30 2 11/16	36 6 3/16	PLUMB SEAT		
42	30 11 1/2	37 4 7/8	13 12		
43	31 8 3/8	38 3 9/16	HIP/VALLEY RAFTERS		
44	32 5 1/4	39 2 1/4	PLUMB SEAT		
45	33 2 1/16	40 1	13 17		
46	33 10 15/16	40 11 5/8	COMMON RAFTERS		
47	34 7 3/4	41 10 5/16			
48	35 4 5/8	42 9			
49	36 1 7/16	43 7 3/4			
50	36 10 5/16	44 6 7/16			

RISE = 13.5 INCHES PER FOOT

BLOG WIDTH FEET	COMMON RAFTER FT INCHES	HIP/VALLEY RAFTER FT INCHES	ADD'L WIDTH INCHES	ADD'L COMMON LENGTH	ADDED HIP/VAL LENGTH
1	0 9	0 10 13/16	0 1/2	0 3/8	0 7/16
2	1 6 1/16	1 9 5/8	1	0 3/4	0 7/8
3	2 3 1/16	2 8 1/2	1 1/2	1 1/8	1 3/8
4	3 0 1/8	3 7 5/16	2	1 1/2	1 13/16
5	3 9 1/8	4 6 3/16	2 1/2	1 7/8	2 1/4
6	4 6 3/16	5 5	3	2 1/4	2 11/16
7	5 3 3/16	6 3 7/8	3 1/2	2 5/8	3 3/16
8	6 0 1/4	7 2 11/16	4	3	3 5/8
9	6 9 1/4	8 1 9/16	4 1/2	3 3/8	4 1/16
10	7 6 5/16	9 0 3/8	5	3 3/4	4 1/2
11	8 3 5/16	9 11 1/4	5 1/2	4 1/8	4 15/16
12	9 0 3/8	10 10 1/16	6	4 1/2	5 7/16
13	9 9 3/8	11 8 15/16	6 1/2	4 7/8	5 7/8
14	10 6 7/16	12 7 3/4	7	5 1/4	6 5/16
15	11 3 7/16	13 6 5/8	7 1/2	5 5/8	6 3/4
16	12 0 1/2	14 5 7/16	8	6	7 1/4
17	12 9 1/2	15 4 5/16	8 1/2	6 3/8	7 11/16
18	13 6 9/16	16 3 1/8	9	6 3/4	8 1/8
19	14 3 9/16	17 2	9 1/2	7 1/8	8 9/16
20	15 0 5/8	18 0 13/16	10	7 1/2	9 1/16
21	15 9 5/8	18 11 11/16	10 1/2	7 7/8	9 1/2
22	16 6 11/16	19 10 1/2	11	8 1/4	9 15/16
23	17 3 11/16	20 9 3/8	11 1/2	8 5/8	10 3/8
24	18 0 3/4	21 8 3/16	12	9	10 13/16
25	18 9 3/4	22 7 1/16			
26	19 6 13/16	23 5 7/8	DIFFERENCE IN JACK RAFTER LENGTHS FOR RAFTER SPACINGS		
27	20 3 13/16	24 4 3/4			
28	21 0 7/8	25 3 9/16			
29	21 9 7/8	26 2 3/8			
30	22 6 15/16	27 1 1/4			
31	23 3 15/16	28 0 1/16			
32	24 1	28 10 15/16			
33	24 10	29 9 3/4			
34	25 7 1/16	30 8 5/8			
35	26 4 1/16	31 7 7/16			
36	27 1 1/8	32 6 5/16			
37	27 10 1/8	33 5 1/8			
38	28 7 3/16	34 4			
39	29 4 3/16	35 2 13/16			
40	30 1 1/4	36 1 11/16			
41	30 10 1/4	37 0 1/2			
42	31 7 5/16	37 11 3/8			
43	32 4 5/16	38 10 3/16			
44	33 1 3/8	39 9 1/16			
45	33 10 3/8	40 7 7/8			
46	34 7 7/16	41 6 3/4			
47	35 4 7/16	42 5 9/16			
48	36 1 1/2	43 4 7/16			
49	36 10 1/2	44 3 1/4			
50	37 7 9/16	45 2 1/8			
			ON CENTER		
			LENGTH DIFFERENCE		
				FEET	INCHES
			12"	1	6 1/16
			16"	2	0 1/16
			18"	2	3 1/16
			20"	2	6 1/8
			24"	3	0 1/8
			PLUMB & SEAT CUTS FOR		
			COMMON RAFTERS		
			PLUMB	SEAT	
			13 1/2	12	
			HIP/VALLEY RAFTERS		
			PLUMB	SEAT	
			13 1/2	17	

RISE = 14 INCHES PER FOOT

BLOG WIDTH FEET	COMMON RAFTER FT INCHES	HIP/VALLEY RAFTER FT INCHES	ADD'L WIDTH INCHES	ADD'L COMMON LENGTH	ADDED HIP/VAL LENGTH
1	0 9 1/4	0 11	0 1/2	0 3/8	0 7/16
2	1 6 7/16	1 10	1	0 3/4	0 15/16
3	2 3 11/16	2 9	1 1/2	1 1/8	1 3/8
4	3 0 7/8	3 8	2	1 9/16	1 13/16
5	3 10 1/8	4 7	2 1/2	1 15/16	2 5/16
6	4 7 5/16	5 6	3	2 5/16	2 3/4
7	5 4 9/16	6 5	3 1/2	2 11/16	3 3/16
8	6 1 3/4	7 4	4	3 1/16	3 11/16
9	6 11	8 3	4 1/2	3 7/16	4 1/8
10	7 8 3/16	9 2	5	3 13/16	4 9/16
11	8 5 7/16	10 1	5 1/2	4 1/4	5 1/16
12	9 2 5/8	11 0	6	4 5/8	5 1/2
13	9 11 7/8	11 11	6 1/2	4 15/16	5 15/16
14	10 9 1/16	12 10	7	5 3/8	6 7/16
15	11 6 5/16	13 9	7 1/2	5 3/4	6 7/8
16	12 3 1/2	14 8	8	6 1/8	7 5/16
17	13 0 3/4	15 7	8 1/2	6 1/2	7 13/16
18	13 9 15/16	16 6	9	6 15/16	8 1/4
19	14 7 3/16	17 5	9 1/2	7 5/16	8 11/16
20	15 4 3/8	18 4	10	7 11/16	9 3/16
21	16 1 5/8	19 3	10 1/2	8 1/16	9 5/8
22	16 10 13/16	20 2	11	8 7/16	10 1/16
23	17 8 1/16	21 1	11 1/2	8 13/16	10 9/16
24	18 5 1/4	22 0	12	9 1/4	11
25	19 2 1/2	22 11	DIFFERENCE IN JACK RAFTER LENGTHS FOR RAFTER SPACINGS		
26	19 11 11/16	23 10	ON CENTER	LENGTH DIFFERENCE	
27	20 8 15/16	24 9		FEET	INCHES
28	21 6 1/8	25 8	12"	1	6 7/16
29	22 3 3/8	26 7	16"	2	0 9/16
30	23 0 9/16	27 6	18"	2	3 11/16
31	23 9 13/16	28 5	20"	2	6 3/4
32	24 7	29 4	24"	3	0 7/8
33	25 4 1/4	30 3	PLUMB & SEAT CUTS FOR		
34	26 1 7/16	31 2	COMMON RAFTERS		
35	26 10 11/16	32 1	PLUMB	SEAT	
36	27 7 7/8	33 0	14	12	
37	28 5 1/8	33 11	HIP/VALLEY RAFTERS		
38	29 2 5/16	34 10	PLUMB	SEAT	
39	29 11 9/16	35 9	14	17	
40	30 8 13/16	36 8			
41	31 6	37 7			
42	32 3 1/4	38 6			
43	33 0 7/16	39 5			
44	33 9 11/16	40 4			
45	34 6 7/8	41 3			
46	35 4 1/8	42 2			
47	36 1 5/16	43 1			
48	36 10 9/16	44 0			
49	37 7 3/4	44 11			
50	38 5	45 10			

RISE = 14.5 INCHES PER FOOT

BLDG WIDTH FEET	COMMON RAFTER FT INCHES	HIP/VALLEY RAFTER FT INCHES	ADD'L WIDTH INCHES	ADD'L COMMON LENGTH	ADDED HIP/VAL LENGTH
1	0 9 7/16	0 11 1/8	0 1/2	0 3/8	0 7/16
2	1 6 13/16	1 10 5/16	1	0 13/16	0 15/16
3	2 4 1/4	2 9 7/16	1 1/2	1 3/16	1 3/8
4	3 1 5/8	3 8 5/8	2	1 9/16	1 7/8
5	3 11 1/16	4 7 3/4	2 1/2	1 15/16	2 5/16
6	4 8 7/16	5 6 15/16	3	2 3/8	2 13/16
7	5 5 7/8	6 6 1/8	3 1/2	2 3/4	3 1/4
8	6 3 5/16	7 5 1/4	4	3 1/8	3 3/4
9	7 0 11/16	8 4 7/16	4 1/2	3 1/2	4 3/16
10	7 10 1/8	9 3 9/16	5	3 15/16	4 5/8
11	8 7 1/2	10 2 3/4	5 1/2	4 5/16	5 1/8
12	9 4 15/16	11 1 7/8	6	4 11/16	5 9/16
13	10 2 5/16	12 1 1/16	6 1/2	5 1/8	6 1/16
14	10 11 3/4	13 0 1/4	7	5 1/2	6 1/2
15	11 9 3/16	13 11 3/8	7 1/2	5 7/8	6 15/16
16	12 6 9/16	14 10 9/16	8	6 1/4	7 7/16
17	13 4	15 9 11/16	8 1/2	6 11/16	7 7/8
18	14 1 3/8	16 8 7/8	9	7 1/16	8 3/8
19	14 10 13/16	17 8	9 1/2	7 7/16	8 13/16
20	15 8 3/16	18 7 3/16	10	7 13/16	9 5/16
21	16 5 5/8	19 6 3/8	10 1/2	8 1/4	9 3/4
22	17 3 1/16	20 5 1/2	11	8 5/8	10 1/4
23	18 0 7/16	21 4 11/16	11 1/2	9	10 11/16
24	18 9 7/8	22 3 13/16	12	9 7/16	11 3/16
25	19 7 1/4	23 3			
26	20 4 11/16	24 2 1/8	DIFFERENCE IN JACK RAFTER LENGTHS FOR RAFTER SPACINGS		
27	21 2 1/16	25 1 5/16			
28	21 11 1/2	26 0 1/2	ON CENTER	LENGTH DIFFERENCE	
29	22 8 15/16	26 11 5/8		FEET	INCHES
30	23 6 5/16	27 10 13/16		1	6 13/16
31	24 3 3/4	28 10		2	1 1/8
32	25 1 1/8	29 9 1/8	12"	2	4 1/4
33	25 10 9/16	30 8 1/4	16"	2	7 3/8
34	26 7 15/16	31 7 7/16	18"	3	1 5/8
35	27 5 3/8	32 6 5/8	20"		
36	28 2 13/16	33 5 3/4	24"		
37	29 0 3/16	34 4 15/16			
38	29 9 5/8	35 4 1/16			
39	30 7	36 3 1/4	PLUMB & SEAT CUTS FOR		
40	31 4 7/16	37 2 3/8	COMMON RAFTERS		
41	32 1 13/16	38 1 9/16	PLUMB	SEAT	
42	32 11 1/4	39 0 3/4	14 1/2	12	
43	33 8 11/16	39 11 7/8	HIP/VALLEY RAFTERS		
44	34 6 1/16	40 11 1/16	PLUMB	SEAT	
45	35 3 1/2	41 10 3/16	14 1/2	17	
46	36 0 7/8	42 9 3/8			
47	36 10 5/16	43 8 1/2			
48	37 7 11/16	44 7 11/16			
49	38 5 1/8	45 6 7/8			
50	39 2 9/16	46 6			

RISE = 15 INCHES PER FOOT

BLDG WIDTH FEET	COMMON RAFTER FT INCHES	HIP/VALLEY RAFTER FT INCHES	ADD'L WIDTH INCHES	ADD L COMMON LENGTH	ADDED HIP/VAL LENGTH
1	0 9 5/8	0 11 5/16	0 1/2	0 3/8	0 1/2
2	1 7 3/16	1 10 5/8	1	0 13/16	0 15/16
3	2 4 13/16	2 10	1 1/2	1 3/16	1 7/16
4	3 2 7/16	3 9 1/4	2	1 5/8	1 7/8
5	4 0	4 8 9/16	2 1/2	2	2 3/8
6	4 9 5/8	5 7 15/16	3	2 3/8	2 13/16
7	5 7 1/4	6 7 1/4	3 1/2	2 13/16	3 5/16
8	6 4 13/16	7 6 9/16	4	3 3/16	3 3/4
9	7 2 7/16	8 5 7/8	4 1/2	3 5/8	4 1/4
10	8 0 1/16	9 5 3/16	5	4	4 11/16
11	8 9 5/8	10 4 9/16	5 1/2	4 3/8	5 3/16
12	9 7 1/4	11 3 7/8	6	4 13/16	5 11/16
13	10 4 7/8	12 3 3/16	6 1/2	5 3/16	6 1/8
14	11 2 7/16	13 2 1/2	7	5 5/8	6 5/8
15	12 0 1/16	14 1 13/16	7 1/2	6	7 1/16
16	12 9 11/16	15 1 3/16	8	6 3/8	7 9/16
17	13 7 1/4	16 0 1/2	8 1/2	6 13/16	8
18	14 4 7/8	16 11 13/16	9	7 3/16	8 1/2
19	15 2 1/2	17 11 1/8	9 1/2	7 5/8	8 15/16
20	16 0 1/16	18 10 7/16	10	8	9 7/16
21	16 9 11/16	19 9 13/16	10 1/2	8 3/8	9 15/16
22	17 7 5/16	20 9 1/8	11	8 13/16	10 3/8
23	18 4 15/16	21 8 7/16	11 1/2	9 3/16	10 7/8
24	19 2 1/2	22 7 3/4	12	9 5/8	11 5/16
25	20 0 1/8	23 7 1/16			
26	20 9 3/4	24 6 7/16			
27	21 7 5/16	25 5 3/4			
28	22 4 15/16	26 5 1/16			
29	23 2 9/16	27 4 3/8			
30	24 0 1/8	28 3 11/16			
31	24 9 3/4	29 3 1/16			
32	25 7 3/8	30 2 3/8			
33	26 4 15/16	31 1 11/16			
34	27 2 9/16	32 1			
35	28 0 3/16	33 0 5/16			
36	28 9 3/4	33 11 11/16			
37	29 7 3/8	34 11			
38	30 5	35 10 5/16			
39	31 2 9/16	36 9 5/8			
40	32 0 3/16	37 9			
41	32 9 13/16	38 8 5/16			
42	33 7 3/8	39 7 5/8			
43	34 5	40 6 15/16			
44	35 2 5/8	41 6 1/4			
45	36 0 3/16	42 5 9/16			
46	36 9 13/16	43 4 15/16			
47	37 7 7/16	44 4 1/4			
48	38 5	45 3 9/16			
49	39 2 5/8	46 2 7/8			
50	40 0 1/4	47 2 3/16			

DIFFERENCE IN JACK RAFTER LENGTHS FOR RAFTER SPACINGS		
ON CENTER	LENGTH DIFFERENCE	
	FEET	INCHES
12"	1	7 3/16
16"	2	1 5/8
18"	2	4 13/16
20"	2	8
24"	3	2 7/16

PLUMB & SEAT CUTS FOR	
COMMON RAFTERS	
PLUMB 15	SEAT 12
HIP/VALLEY RAFTERS	
PLUMB 15	SEAT 17

RISE = 15.5 INCHES PER FOOT

BLDG WIDTH FEET	COMMON RAFTER FT INCHES	HIP/VALLEY RAFTER FT INCHES	ADD'L WIDTH INCHES	ADD'L COMMON LENGTH	ADDED HIP/VAL LENGTH
1	0 9 13/16	0 11 7/16	0 1/2	0 7/16	0 1/2
2	1 7 5/8	1 11	1	0 13/16	0 15/16
3	2 5 3/8	2 10 7/16	1 1/2	1 1/4	1 7/16
4	3 3 3/16	3 9 15/16	2	1 5/8	1 15/16
5	4 1	4 9 7/16	2 1/2	2 1/16	2 3/8
6	4 10 13/16	5 8 15/16	3	2 7/16	2 7/8
7	5 8 5/8	6 8 7/16	3 1/2	2 7/8	3 3/8
8	6 6 7/16	7 7 7/8	4	3 1/4	3 13/16
9	7 4 3/16	8 7 3/8	4 1/2	3 11/16	4 5/16
10	8 2	9 6 7/8	5	4 1/16	4 13/16
11	8 11 13/16	10 6 3/8	5 1/2	4 1/2	5 1/4
12	9 9 5/8	11 5 7/8	6	4 7/8	5 3/4
13	10 7 7/16	12 5 3/8	6 1/2	5 5/16	6 1/4
14	11 5 3/16	13 4 7/8	7	5 11/16	6 11/16
15	12 3	14 4 3/8	7 1/2	6 1/8	7 3/16
16	13 0 13/16	15 3 13/16	8	6 9/16	7 11/16
17	13 10 5/8	16 3 5/16	8 1/2	6 15/16	8 1/8
18	14 8 7/16	17 2 13/16	9	7 3/8	8 5/8
19	15 6 1/4	18 2 5/16	9 1/2	7 3/4	9 1/8
20	16 4	19 1 13/16	10	8 3/16	9 9/16
21	17 1 13/16	20 1 5/16	10 1/2	8 9/16	10 1/16
22	17 11 5/8	21 0 13/16	11	8 15/16	10 9/16
23	18 9 7/16	22 0 1/4	11 1/2	9 3/8	11
24	19 7 1/4	22 11 3/4	12	9 13/16	11 1/2
25	20 5	23 11 1/4	DIFFERENCE IN JACK RAFTER LENGTHS FOR RAFTER SPACINGS		
26	21 2 13/16	24 10 3/4	ON CENTER LENGTH DIFFERENCE		
27	22 0 5/8	25 10 1/4			
28	22 10 7/16	26 9 3/4	FEET INCHES		
29	23 8 1/4	27 9 1/4			
30	24 6 1/16	28 8 3/4	12" 1		
31	25 3 13/16	29 8 3/16			
32	26 1 5/8	30 7 11/16	16" 2		
33	26 11 7/16	31 7 3/16			
34	27 9 1/4	32 6 11/16	18" 2		
35	28 7 1/16	33 6 3/16			
36	29 4 13/16	34 5 11/16	20" 2		
37	30 2 5/8	35 5 3/16			
38	31 0 7/16	36 4 11/16	24" 3		
39	31 10 1/4	37 4 1/8			
40	32 8 1/16	38 3 5/8	PLUMB & SEAT CUTS FOR COMMON RAFTERS PLUMB SEAT 15 1/2 12 HIP/VALLEY RAFTERS PLUMB SEAT 15 1/2 17		
41	33 5 7/8	39 3 1/8			
42	34 3 5/8	40 2 5/8			
43	35 1 7/16	41 2 1/8			
44	35 11 1/4	42 1 5/8			
45	36 9 1/16	43 1 1/8			
46	37 6 7/8	44 0 9/16			
47	38 4 5/8	45 0 1/16			
48	39 2 7/16	45 11 9/16			
49	40 0 1/4	46 11 1/16			
50	40 10 1/16	47 10 9/16			

RISE = 16 INCHES PER FOOT

BLOG WIDTH FEET	COMMON RAFTER FT INCHES	HIP/VALLEY RAFTER FT INCHES	ADD'L WIDTH INCHES	ADD'L COMMON LENGTH	ADDED HIP/VAL LENGTH
1	0 10	0 11 5/8	0 1/2	0 7/16	0 1/2
2	1 8	1 11 5/16	1	0 13/16	0 15/16
3	2 6	2 11	1 1/2	1 1/4	1 7/16
4	3 4	3 10 5/8	2	1 11/16	1 15/16
5	4 2	4 10 1/4	2 1/2	2 1/16	2 7/16
6	5 0	5 10	3	2 1/2	2 15/16
7	5 10	6 9 5/8	3 1/2	2 15/16	3 3/8
8	6 8	7 9 1/4	4	3 5/16	3 7/8
9	7 6	8 8 15/16	4 1/2	3 3/4	4 3/8
10	8 4	9 8 9/16	5	4 3/16	4 7/8
11	9 2	10 8 1/4	5 1/2	4 9/16	5 3/8
12	10 0	11 7 15/16	6	5	5 13/16
13	10 10	12 7 9/16	6 1/2	5 7/16	6 5/16
14	11 8	13 7 1/4	7	5 13/16	6 13/16
15	12 6	14 6 7/8	7 1/2	6 1/4	7 5/16
16	13 4	15 6 9/16	8	6 11/16	7 3/4
17	14 2	16 6 1/4	8 1/2	7 1/16	8 1/4
18	15 0	17 5 7/8	9	7 1/2	8 3/4
19	15 10	18 5 9/16	9 1/2	7 15/16	9 1/4
20	16 8	19 5 3/16	10	8 5/16	9 11/16
21	17 6	20 4 7/8	10 1/2	8 3/4	10 3/16
22	18 4	21 4 1/2	11	9 3/16	10 11/16
23	19 2	22 4 3/16	11 1/2	9 9/16	11 3/16
24	20 0	23 3 7/8	12	10	11 11/16
25	20 10	24 3 1/2			
26	21 8	25 3 3/16			
27	22 6	26 2 13/16			
28	23 4	27 2 1/2			
29	24 2	28 2 3/16			
30	25 0	29 1 13/16			
31	25 10	30 1 1/2			
32	26 8	31 1 1/8			
33	27 6	32 0 13/16			
34	28 4	33 0 1/2			
35	29 2	34 0 1/8			
36	30 0	34 11 13/16			
37	30 10	35 11 7/16			
38	31 8	36 11 1/8			
39	32 6	37 10 13/16			
40	33 4	38 10 7/16			
41	34 2	39 10 1/8			
42	35 0	40 9 3/4			
43	35 10	41 9 7/16			
44	36 8	42 9 1/16			
45	37 6	43 8 3/4			
46	38	44 8 7/16			
47	39 2	45 8 1/16			
48	40 0	46 7 3/4			
49	40 10	47 7 3/8			
50	41 8	48 7 1/16			

DIFFERENCE IN JACK RAFTER LENGTHS FOR RAFTER SPACINGS		
ON CENTER	LENGTH DIFFERENCE	
	FEET	INCHES
12"	1	8
16"	2	2 11/16
18"	2	6
20"	2	9 5/16
24"	3	4

PLUMB & SEAT CUTS FOR	
COMMON RAFTERS	
PLUMB 16	SEAT 12
HIP/VALLEY RAFTERS	
PLUMB 16	SEAT 17

RISE = 16.5 INCHES PER FOOT

BLDG WIDTH FEET	COMMON RAFTER FT INCHES	HIP/VALLEY RAFTER FT INCHES	ADD'L WIDTH INCHES	ADD'L COMMON LENGTH	ADDED HIP/VAL LENGTH
1	0 10 3/16	0 11 13/16	0 1/2	0 7/16	0 1/2
2	1 8 3/8	1 11 5/8	1	0 7/8	0 15/16
3	2 6 5/8	2 11 1/2	1 1/2	1 1/4	1 1/2
4	3 4 13/16	3 11 5/16	2	1 11/16	1 15/16
5	4 3	4 11 1/8	2 1/2	2 1/8	2 7/16
6	5 1 3/16	5 11	3	2 9/16	2 15/16
7	5 11 7/16	6 10 13/16	3 1/2	2 15/16	3 7/16
8	6 9 5/8	7 10 5/8	4	3 3/8	3 15/16
9	7 7 13/16	8 10 1/2	4 1/2	3 13/16	4 7/16
10	8 6	9 10 5/16	5	4 1/4	4 15/16
11	9 4 3/16	10 10 1/8	5 1/2	4 11/16	5 7/16
12	10 2 7/16	11 10	6	5 1/8	5 15/16
13	11 0 5/8	12 9 13/16	6 1/2	5 1/2	6 7/16
14	11 10 13/16	13 9 5/8	7	5 15/16	6 7/8
15	12 9	14 9 1/2	7 1/2	6 3/8	7 3/8
16	13 7 3/16	15 9 5/16	8	6 13/16	7 7/8
17	14 5 7/16	16 9 3/16	8 1/2	7 1/4	8 3/8
18	15 3 5/8	17 9	9	7 5/8	8 7/8
19	16 1 13/16	18 8 13/16	9 1/2	8 1/16	9 3/8
20	17 0	19 8 11/16	10	8 1/2	9 7/8
21	17 10 1/4	20 8 1/2	10 1/2	8 15/16	10 3/8
22	18 8 7/16	21 8 5/16	11	9 3/8	10 7/8
23	19 6 5/8	22 8 3/16	11 1/2	9 3/4	11 5/16
24	20 4 13/16	23 8	12	10 3/16	11 13/16
25	21 3	24 7 13/16			
26	22 1 1/4	25 7 11/16			
27	22 11 7/16	26 7 1/2			
28	23 9 5/8	27 7 5/16			
29	24 7 13/16	28 7 3/16			
30	25 6 1/16	29 7			
31	26 4 1/4	30 6 7/8			
32	27 2 7/16	31 6 11/16			
33	28 0 5/8	32 6 1/2			
34	28 10 13/16	33 6 3/8			
35	29 9 1/16	34 6 3/16			
36	30 7 1/4	35 6			
37	31 5 7/16	36 5 7/8			
38	32 3 5/8	37 5 11/16			
39	33 1 13/16	38 5 1/2			
40	34 0 1/16	39 5 3/8			
41	34 10 1/4	40 5 3/16			
42	35 8 7/16	41 5			
43	36 6 5/8	42 4 7/8			
44	37 4 7/8	43 4 11/16			
45	38 3 1/16	44 4 9/16			
46	39 1 1/4	45 4 3/8			
47	39 11 7/16	46 4 3/16			
48	40 9 5/8	47 4 1/16			
49	41 7 7/8	48 3 7/8			
50	42 6 1/16	49 3 11/16			

DIFFERENCE IN JACK RAFTER LENGTHS FOR RAFTER SPACINGS		
ON CENTER	LENGTH DIFFERENCE	
	FEET	INCHES
12"	1	8 3/8
16"	2	3 3/16
18"	2	6 5/8
20"	2	10
24"	3	4 13/16

PLUMB & SEAT CUTS FOR	
COMMON RAFTERS	
PLUMB	SEAT
16 1/2	12
HIP/VALLEY RAFTERS	
PLUMB	SEAT
8 1/4	8 1/2

RISE = 17 INCHES PER FOOT

BLDG WIDTH FEET	COMMON RAFTER FT INCHES	HIP/VALLEY RAFTER FT INCHES	ADD L WIDTH INCHES	ADD'L COMMON LENGTH	ADDED HIP/VAL LENGTH
1	0 10 3/8	1 0	0 1/2	0 7/16	0 1/2
2	1 8 13/16	2 0	1	0 7/8	1
3	2 7 3/16	3 0	1 1/2	1 5/16	1 1/2
4	3 5 5/8	4 0	2	1 3/4	2
5	4 4	5 0	2 1/2	2 3/16	2 1/2
6	5 2 7/16	6 0	3	2 5/8	3
7	6 0 13/16	7 0 1/16	3 1/2	3 1/16	3 1/2
8	6 11 1/4	8 0 1/16	4	3 7/16	4
9	7 9 5/8	9 0 1/16	4 1/2	3 7/8	4 1/2
10	8 8 1/16	10 0 1/16	5	4 5/16	5
11	9 6 7/16	11 0 1/16	5 1/2	4 3/4	5 1/2
12	10 4 7/8	12 0 1/16	6	5 3/16	6
13	11 3 1/4	13 0 1/8	6 1/2	5 5/8	6 1/2
14	12 1 11/16	14 0 1/8	7	6 1/16	7
15	13 0 1/16	15 0 1/8	7 1/2	6 1/2	7 1/2
16	13 10 1/2	16 0 1/8	8	6 15/16	8
17	14 8 7/8	17 0 1/8	8 1/2	7 3/8	8 1/2
18	15 7 1/4	18 0 1/8	9	7 13/16	9
19	16 5 11/16	19 0 3/16	9 1/2	8 1/4	9 1/2
20	17 4 1/16	20 0 3/16	10	8 11/16	10
21	18 2 1/2	21 0 3/16	10 1/2	9 1/8	10 1/2
22	19 0 7/8	22 0 3/16	11	9 9/16	11
23	19 11 5/16	23 0 3/16	11 1/2	9 15/16	11 1/2
24	20 9 11/16	24 0 3/16	12	10 3/8	12
25	21 8 1/8	25 0 1/4	DIFFERENCE IN JACK RAFTER LENGTHS FOR RAFTER SPACINGS		
26	22 6 1/2	26 0 1/4			
27	23 4 15/16	27 0 1/4	ON CENTER LENGTH DIFFERENCE		
28	24 3 5/16	28 0 1/4			
29	25 1 3/4	29 0 1/4	FEET INCHES		
30	26 0 1/8	30 0 1/4			
31	26 10 9/16	31 0 5/16	12" 1 8 13/16		
32	27 8 15/16	32 0 5/16			
33	28 7 5/16	33 0 5/16	16" 2 3 3/4		
34	29 5 3/4	34 0 5/16			
35	30 4 1/8	35 0 5/16	18" 2 7 3/16		
36	31 2 9/16	36 0 5/16			
37	32 0 15/16	37 0 3/8	20" 2 10 11/16		
38	32 11 3/8	38 0 3/8			
39	33 9 3/4	39 0 3/8	24" 3 5 5/8		
40	34 8 3/16	40 0 3/8			
41	35 6 9/16	41 0 3/8	PLUMB & SEAT CUTS FOR COMMON RAFTERS PLUMB SEAT 17 12 HIP/VALLEY RAFTERS PLUMB SEAT 8 1/2 8 1/2		
42	36 5	42 0 3/8			
43	37 3 3/8	43 0 7/16			
44	38 1 13/16	44 0 7/16			
45	39 0 3/16	45 0 7/16			
46	39 10 5/8	46 0 7/16			
47	40 9	47 0 7/16			
48	41 7 7/16	48 0 7/16			
49	42 5 13/16	49 0 1/2			
50	43 4 3/16	50 0 1/2			

RISE = 17.5 INCHES PER FOOT

BLDG WIDTH FEET	COMMON RAFTER FT INCHES	HIP/VALLEY RAFTER FT INCHES	ADD'L WIDTH INCHES	ADD L COMMON LENGTH	ADDED HIP/VAL LENGTH
1	0 10 5/8	1 0 3/16	0 1/2	0 7/16	0 1/2
2	1 9 1/4	2 0 3/8	1	0 7/8	1
3	2 7 13/16	3 0 9/16	1 1/2	1 5/16	1 1/2
4	3 6 7/16	4 0 3/4	2	1 3/4	2 1/16
5	4 5 1/16	5 0 15/16	2 1/2	2 3/16	2 9/16
6	5 3 11/16	6 1 1/8	3	2 5/8	3 1/16
7	6 2 1/4	7 1 5/16	3 1/2	3 1/8	3 9/16
8	7 0 7/8	8 1 1/2	4	3 9/16	4 1/16
9	7 11 1/2	9 1 11/16	4 1/2	3 15/16	4 9/16
10	8 10 1/8	10 1 7/8	5	4 7/16	5 1/16
11	9 8 11/16	11 2 1/16	5 1/2	4 7/8	5 9/16
12	10 7 5/16	12 2 1/4	6	5 5/16	6 1/8
13	11 5 15/16	13 2 7/16	6 1/2	5 3/4	6 5/8
14	12 4 9/16	14 2 5/8	7	6 3/16	7 1/8
15	13 3 1/8	15 2 13/16	7 1/2	6 5/8	7 5/8
16	14 1 3/4	16 3	8	7 1/16	8 1/8
17	15 0 3/8	17 3 3/16	8 1/2	7 1/2	8 5/8
18	15 11	18 3 3/8	9	7 15/16	9 1/8
19	16 9 9/16	19 3 9/16	9 1/2	8 3/8	9 5/8
20	17 8 3/16	20 3 3/4	10	8 13/16	10 3/16
21	18 6 13/16	21 3 15/16	10 1/2	9 5/16	10 11/16
22	19 5 7/16	22 4 1/8	11	9 3/4	11 3/16
23	20 4	23 4 5/16	11 1/2	10 3/16	11 11/16
24	21 2 5/8	24 4 1/2	12	10 5/8	12 3/16
25	22 1 1/4	25 4 11/16			
26	22 11 7/8	26 4 7/8			
27	23 10 7/16	27 5 1/16			
28	24 9 1/16	28 5 1/4			
29	25 7 11/16	29 5 7/16			
30	26 6 5/16	30 5 5/8			
31	27 4 7/8	31 5 13/16			
32	28 3 1/2	32 6			
33	29 2 1/8	33 6 3/16			
34	30 0 3/4	34 6 3/8			
35	30 11 5/16	35 6 9/16			
36	31 9 15/16	36 6 3/4			
37	32 8 9/16	37 7			
38	33 7 3/16	38 7 1/8			
39	34 5 3/4	39 7 5/16			
40	35 4 3/8	40 7 1/2			
41	36 3	41 7 11/16			
42	37 1 5/8	42 7 7/8			
43	38 0 3/16	43 8 1/16			
44	38 10 13/16	44 8 1/4			
45	39 9 7/16	45 8 7/16			
46	40 8 1/16	46 8 5/8			
47	41 6 5/8	47 8 13/16			
48	42 5 1/4	48 9			
49	43 3 7/8	49 9 3/16			
50	44 2 1/2	50 9 3/8			

DIFFERENCE IN JACK RAFTER LENGTHS FOR RAFTER SPACINGS		
ON CENTER	LENGTH DIFFERENCE	
	FEET	INCHES
12"	1	9 1/4
16"	2	4 5/16
18"	2	7 13/16
20"	2	11 3/8
24"	3	6 7/16

PLUMB & SEAT CUTS FOR	
COMMON RAFTERS	
PLUMB 17 1/2	SEAT 12
HIP/VALLEY RAFTERS	
PLUMB 8 3/4	SEAT 8 1/2

RISE = 18 INCHES PER FOOT

BLDG WIDTH FEET	COMMON RAFTER FT INCHES	HIP/VALLEY RAFTER FT INCHES	ADD'L WIDTH INCHES	ADD L COMMON LENGTH	ADDED HIP/VAL LENGTH
1	0 10 13/16	1 0 5/16	0 1/2	0 7/16	0 1/2
2	1 9 5/8	2 0 11/16	1	0 7/8	1
3	2 8 7/16	3 1 1/16	1 1/2	1 3/8	1 9/16
4	3 7 1/4	4 1 7/16	2	1 13/16	2 1/16
5	4 6 1/16	5 1 13/16	2 1/2	2 1/4	2 9/16
6	5 4 7/8	6 2 3/16	3	2 11/16	3 1/16
7	6 3 11/16	7 2 9/16	3 1/2	3 1/8	3 5/8
8	7 2 9/16	8 2 15/16	4	3 5/8	4 1/8
9	8 1 3/8	9 3 5/16	4 1/2	4 1/16	4 5/8
10	9 0 3/16	10 3 11/16	5	4 1/2	5 1/8
11	9 11	11 4	5 1/2	4 15/16	5 11/16
12	10 9 13/16	12 4 3/8	6	5 7/16	6 3/16
13	11 8 5/8	13 4 3/4	6 1/2	5 7/8	6 11/16
14	12 7 7/16	14 5 1/8	7	6 5/16	7 3/16
15	13 6 1/4	15 5 1/2	7 1/2	6 3/4	7 3/4
16	14 5 1/16	16 5 7/8	8	7 3/16	8 1/4
17	15 3 7/8	17 6 1/4	8 1/2	7 11/16	8 3/4
18	16 2 11/16	18 6 5/8	9	8 1/8	9 1/4
19	17 1 1/2	19 7	9 1/2	8 9/16	9 13/16
20	18 0 5/16	20 7 3/8	10	9	10 5/16
21	18 11 1/8	21 7 3/4	10 1/2	9 7/16	10 13/16
22	19 9 15/16	22 8 1/16	11	9 15/16	11 5/16
23	20 8 13/16	23 8 7/16	11 1/2	10 3/8	11 7/8
24	21 7 5/8	24 8 13/16	12	10 13/16	12 3/8
25	22 6 7/16	25 9 3/16			
26	23 5 1/4	26 9 9/16			
27	24 4 1/16	27 10			
28	25 2 7/8	28 10 5/16			
29	26 1 11/16	29 10 11/16			
30	27 0 1/2	30 11 1/16			
31	27 11 5/16	31 11 7/16			
32	28 10 1/8	32 11 13/16			
33	29 8 15/16	34 0 1/8			
34	30 7 3/4	35 0 1/2			
35	31 6 9/16	36 0 7/8			
36	32 5 3/8	37 1 1/4			
37	33 4 3/16	38 1 5/8			
38	34 3 1/16	39 2			
39	35 1 7/8	40 2 3/8			
40	36 0 11/16	41 2 3/4			
41	36 11 1/2	42 3 1/8			
42	37 10 5/16	43 3 1/2			
43	38 9 1/8	44 3 7/8			
44	39 7 15/16	45 4 3/16			
45	40 6 3/4	46 4 9/16			
46	41 5 9/16	47 5			
47	42 4 3/8	48 5 5/16			
48	43 3 3/16	49 5 11/16			
49	44 2	50 6 1/16			
50	45 0 13/16	51 6 7/16			

DIFFERENCE IN JACK RAFTER LENGTHS FOR RAFTER SPACINGS		
ON CENTER	LENGTH DIFFERENCE	
	FEET	INCHES
12"	1	9 5/8
16"	2	4 7/8
18"	2	8 7/16
20"	3	0 1/16
24"	3	7 1/4

PLUMB & SEAT CUTS FOR	
COMMON RAFTERS	
PLUMB 18	SEAT 12
HIP/VALLEY RAFTERS	
PLUMB 9	SEAT 8 1/2

RISE = 18.5 INCHES PER FOOT

BLDG WIDTH FEET	COMMON RAFTER FT INCHES	HIP/VALLEY RAFTER FT INCHES	ADD L WIDTH INCHES	ADD L COMMON LENGTH	ADDED HIP/VAL LENGTH
1	0 11	1 0 1/2	0 1/2	0 7/16	0 1/2
2	1 10 1/16	2 1 1/16	1	0 15/16	1 1/16
3	2 9 1/16	3 1 5/8	1 1/2	1 3/8	1 9/16
4	3 8 1/8	4 2 3/16	2	1 13/16	2 1/16
5	4 7 1/8	5 2 3/4	2 1/2	2 5/16	2 5/8
6	5 6 1/8	6 3 5/16	3	2 3/4	3 1/8
7	6 5 3/16	7 3 13/16	3 1/2	3 3/16	3 11/16
8	7 4 3/16	8 4 3/8	4	3 11/16	4 3/16
9	8 3 1/4	9 5	4 1/2	4 1/8	4 11/16
10	9 2 1/4	10 5 1/2	5	4 5/8	5 1/4
11	10 1 1/4	11 6 1/16	5 1/2	5 1/16	5 3/4
12	11 0 5/16	12 6 5/8	6	5 1/2	6 1/4
13	11 11 5/16	13 7 1/8	6 1/2	5 15/16	6 13/16
14	12 10 3/8	14 7 11/16	7	6 7/16	7 5/16
15	13 9 3/8	15 8 1/4	7 1/2	6 7/8	7 7/8
16	14 8 7/16	16 8 13/16	8	7 3/8	8 3/8
17	15 7 7/16	17 9 3/8	8 1/2	7 13/16	8 7/8
18	16 6 7/16	18 9 15/16	9	8 1/4	9 7/16
19	17 5 1/2	19 10 7/16	9 1/2	8 3/4	9 15/16
20	18 4 1/2	20 11	10	9 3/16	10 7/16
21	19 3 9/16	21 11 9/16	10 1/2	9 5/8	10 15/16
22	20 2 9/16	23 0 1/8	11	10 1/8	11 1/2
23	21 1 9/16	24 0 11/16	11 1/2	10 9/16	12
24	22 0 5/8	25 1 1/4	12	11	12 9/16
25	22 11 5/8	26 1 3/4			
26	23 10 11/16	27 2 5/16			
27	24 9 11/16	28 2 7/8			
28	25 8 11/16	29 3 7/16			
29	26 7 3/4	30 4			
30	27 6 3/4	31 4 9/16			
31	28 5 13/16	32 5 1/16			
32	29 4 13/16	33 5 5/8			
33	30 3 13/16	34 6 3/16			
34	31 2 7/8	35 6 3/4			
35	32 1 7/8	36 7 5/16			
36	33 0 15/16	37 7 7/8			
37	33 11 15/16	38 8 7/16			
38	34 11	39 9			
39	35 10	40 9 1/2			
40	36 9	41 10 1/16			
41	37 8 1/16	42 10 5/8			
42	38 7 1/16	43 11 3/16			
43	39 6 1/8	44 11 3/4			
44	40 5 1/8	46 0 1/4			
45	41 4 1/8	47 0 13/16			
46	42 3 3/16	48 1 3/8			
47	43 2 3/16	49 1 15/16			
48	44 1 1/4	50 2 1/2			
49	45 0 1/4	51 3 1/16			
50	45 11 1/4	52 3 9/16			

DIFFERENCE IN JACK RAFTER LENGTHS FOR RAFTER SPACINGS		
ON CENTER	LENGTH DIFFERENCE	
	FEET	INCHES
12"	1	10 1/16
16"	2	5 3/8
18"	2	9 1/16
20"	3	0 3/4
24"	3	8 1/8

PLUMB & SEAT CUTS FOR	
COMMON RAFTERS	
PLUMB	SEAT
18 1/2	12
HIP/VALLEY RAFTERS	
PLUMB	SEAT
9 1/4	8 1/2

RISE = 19 INCHES PER FOOT

BLDG WIDTH FEET	COMMON RAFTER FT INCHES	HIP/VALLEY RAFTER FT INCHES	ADD'L WIDTH INCHES	ADD'L COMMON LENGTH	ADDED HIP/VAL LENGTH
1	0 11 1/4	1 0 11/16	0 1/2	0 7/16	0 1/2
2	1 10 1/2	2 1 7/16	1	0 15/16	1 1/16
3	2 9 11/16	3 2 3/16	1 1/2	1 3/8	1 9/16
4	3 8 15/16	4 2 15/16	2	1 7/8	2 1/8
5	4 8 3/16	5 3 11/16	2 1/2	2 5/16	2 5/8
6	5 7 7/16	6 4 3/8	3	2 13/16	3 3/16
7	6 6 5/8	7 5 1/8	3 1/2	3 1/4	3 11/16
8	7 5 7/8	8 5 7/8	4	3 3/4	4 1/4
9	8 5 1/8	9 6 5/8	4 1/2	4 3/16	4 3/4
10	9 4 3/8	10 7 3/8	5	4 11/16	5 5/16
11	10 3 5/8	11 8 1/16	5 1/2	5 1/8	5 13/16
12	11 2 13/16	12 8 13/16	6	5 5/8	6 3/8
13	12 2 1/16	13 9 9/16	6 1/2	6 1/16	6 7/8
14	13 1 5/16	14 10 5/16	7	6 9/16	7 7/16
15	14 0 9/16	15 11 1/16	7 1/2	7	7 15/16
16	14 11 3/4	16 11 3/4	8	7 1/2	8 1/2
17	15 11	18 0 1/2	8 1/2	7 15/16	9
18	16 10 1/4	19 1 1/4	9	8 7/16	9 9/16
19	17 9 1/2	20 2	9 1/2	8 7/8	10 1/16
20	18 8 3/4	21 2 3/4	10	9 3/8	10 5/8
21	19 7 15/16	22 3 7/16	10 1/2	9 13/16	11 1/8
22	20 7 3/16	23 4 3/16	11	10 5/16	11 11/16
23	21 6 7/16	24 4 15/16	11 1/2	10 3/4	12 3/16
24	22 5 11/16	25 5 11/16	12	11 1/4	12 3/4
25	23 4 7/8	26 6 7/16			
26	24 4 1/8	27 7 1/8			
27	25 3 3/8	28 7 7/8			
28	26 2 5/8	29 8 5/8			
29	27 1 7/8	30 9 3/8			
30	28 1 1/16	31 10 1/8			
31	29 0 5/16	32 10 13/16			
32	29 11 9/16	33 11 9/16			
33	30 10 13/16	35 0 5/16			
34	31 10	36 1 1/16			
35	32 9 1/4	37 1 13/16			
36	33 8 1/2	38 2 1/2			
37	34 7 3/4	39 3 1/4			
38	35 7	40 4			
39	36 6 3/16	41 4 3/4			
40	37 5 7/16	42 5 1/2			
41	38 4 11/16	43 6 3/16			
42	39 3 15/16	44 7			
43	40 3 1/8	45 7 11/16			
44	41 2 3/8	46 8 7/16			
45	42 1 5/8	47 9 3/16			
46	43 0 7/8	48 9 7/8			
47	44 0 1/8	49 10 5/8			
48	44 11 5/16	50 11 3/8			
49	45 10 9/16	52 0 1/8			
50	46 9 13/16	53 0 7/8			

DIFFERENCE IN JACK RAFTER LENGTHS FOR RAFTER SPACINGS		
ON CENTER	LENGTH DIFFERENCE	
	FEET	INCHES
12"	1	10 1/2
16"	2	5 15/16
18"	2	9 11/16
20"	3	1 7/16
24"	3	8 15/16

PLUMB & SEAT CUTS FOR		
COMMON RAFTERS		
PLUMB	SEAT	
19	12	
HIP/VALLEY RAFTERS		
PLUMB	SEAT	
9 5	8 1/2	

RISE = 19.5 INCHES PER FOOT

BLDG WIDTH FEET	COMMON RAFTER FT INCHES	HIP/VALLEY RAFTER FT INCHES	ADD'L WIDTH INCHES	ADD'L COMMON LENGTH	ADDED HIP/VAL LENGTH
1	0 11 7/16	1 0 7/8	0 1/2	0 1/2	0 9/16
2	1 10 7/8	2 1 13/16	1	0 15/16	1 1/16
3	2 10 3/8	3 2 3/4	1 1/2	1 7/16	1 5/8
4	3 9 13/16	4 3 11/16	2	1 15/16	2 1/8
5	4 9 1/4	5 4 5/8	2 1/2	2 3/8	2 11/16
6	5 8 11/16	6 5 1/2	3	2 7/8	3 1/4
7	6 8 1/8	7 6 7/16	3 1/2	3 5/16	3 3/4
8	7 7 9/16	8 7 3/8	4	3 13/16	4 5/16
9	8 7 1/16	9 8 5/16	4 1/2	4 5/16	4 7/8
10	9 6 1/2	10 9 1/4	5	4 3/4	5 3/8
11	10 5 15/16	11 10 1/8	5 1/2	5 1/4	5 15/16
12	11 5 3/8	12 11 1/16	6	5 3/4	6 7/16
13	12 4 13/16	14 0	6 1/2	6 3/16	7
14	13 4 1/4	15 0 15/16	7	6 11/16	7 9/16
15	14 3 3/4	16 1 7/8	7 1/2	7 1/8	8 1/16
16	15 3 3/16	17 2 3/4	8	7 5/8	8 5/8
17	16 2 5/8	18 3 11/16	8 1/2	8 1/8	9 1/8
18	17 2 1/16	19 4 5/8	9	8 9/16	9 11/16
19	18 1 1/2	20 5 9/16	9 1/2	9 1/16	10 1/4
20	19 0 15/16	21 6 1/2	10	9 9/16	10 3/4
21	20 0 7/16	22 7 3/8	10 1/2	10	11 5/16
22	20 11 7/8	23 8 5/16	11	10 1/2	11 7/8
23	21 11 5/16	24 9 1/4	11 1/2	10 15/16	12 3/8
24	22 10 3/4	25 10 3/16	12	11 7/16	12 15/16
25	23 10 3/16	26 11 1/8			
26	24 9 5/8	28 0			
27	25 9 1/8	29 1			
28	26 8 9/16	30 1 7/8			
29	27 8	31 2 13/16			
30	28 7 7/16	32 3 3/4			
31	29 6 7/8	33 4 5/8			
32	30 6 3/8	34 5 9/16			
33	31 5 13/16	35 6 1/2			
34	32 5 1/4	36 7 7/16			
35	33 4 11/16	37 8 3/8			
36	34 4 1/8	38 9 1/4			
37	35 3 9/16	39 10 3/16			
38	36 3 1/16	40 11 1/8			
39	37 2 1/2	42 0 1/16			
40	38 1 15/16	43 1			
41	39 1 3/8	44 1 7/8			
42	40 0 13/16	45 2 13/16			
43	41 0 1/4	46 3 3/4			
44	41 11 3/4	47 4 11/16			
45	42 11 3/16	48 5 5/8			
46	43 10 5/8	49 6 1/2			
47	44 10 1/16	50 7 7/16			
48	45 9 1/2	51 8 3/8			
49	46 8 15/16	52 9 5/16			
50	47 8 7/16	53 10 1/4			

DIFFERENCE IN JACK RAFTER LENGTHS FOR RAFTER SPACINGS		
ON CENTER	LENGTH DIFFERENCE	
	FEET	INCHES
12"	1	10 7/8
16"	2	6 1/2
18"	2	10 3/8
20"	3	2 3/16
24"	3	9 13/16

PLUMB & SEAT CUTS FOR	
COMMON RAFTERS	
PLUMB	SEAT
19 1/2	12
HIP/VALLEY RAFTERS	
PLUMB	SEAT
9 3/4	8 1/2

RISE = 20 INCHES PER FOOT

BLDG WIDTH FEET	COMMON RAFTER FT INCHES	HIP/VALLEY RAFTER FT INCHES	ADD'L WIDTH INCHES	ADD'L COMMON LENGTH	ADDED HIP/VAL LENGTH
1	0 11 11/16	1 1 1/16	0 1/2	0 1/2	0 9/16
2	1 11 5/16	2 2 3/16	1	0 15/16	1 1/16
3	2 11	3 3 5/16	1 1/2	1 7/16	1 5/8
4	3 10 5/8	4 4 7/16	2	1 15/16	2 3/16
5	4 10 5/16	5 5 9/16	2 1/2	2 7/16	2 3/4
6	5 10	6 6 11/16	3	2 15/16	3 1/4
7	6 9 5/8	7 7 3/4	3 1/2	3 3/8	3 13/16
8	7 9 5/16	8 8 7/8	4	3 7/8	4 3/8
9	8 8 15/16	9 10	4 1/2	4 3/8	4 15/16
10	9 8 5/8	10 11 1/8	5	4 7/8	5 7/16
11	10 8 1/4	12 0 1/4	5 1/2	5 3/8	6
12	11 7 15/16	13 1 3/8	6	5 13/16	6 9/16
13	12 7 5/8	14 2 7/16	6 1/2	6 5/16	7 1/8
14	13 7 1/4	15 3 9/16	7	6 13/16	7 5/8
15	14 6 15/16	16 4 11/16	7 1/2	7 5/16	8 3/16
16	15 6 9/16	17 5 13/16	8	7 3/4	8 3/4
17	16 6 1/4	18 6 15/16	8 1/2	8 1/4	9 5/16
18	17 5 15/16	19 8 1/16	9	8 3/4	9 13/16
19	18 5 9/16	20 9 1/8	9 1/2	9 1/4	10 3/8
20	19 5 1/4	21 10 1/4	10	9 11/16	10 15/16
21	20 4 7/8	22 11 3/8	10 1/2	10 3/16	11 1/2
22	21 4 9/16	24 0 1/2	11	10 11/16	12
23	22 4 1/4	25 1 5/8	11 1/2	11 3/16	12 9/16
24	23 3 7/8	26 2 3/4	12	11 11/16	13 1/8
25	24 3 9/16	27 3 13/16			
26	25 3 3/16	28 5			
27	26 2 7/8	29 6 1/16	DIFFERENCE IN JACK RAFTER LENGTHS FOR RAFTER SPACINGS		
28	27 2 9/16	30 7 3/16			
29	28 2 3/16	31 8 5/16	ON CENTER	LENGTH DIFFERENCE	
30	29 1 7/8	32 9 7/16		FEET	INCHES
31	30 1 1/2	33 10 1/2	12"	1	11 5/16
32	31 1 3/16	34 11 5/8	16"	2	7 1/8
33	32 0 13/16	36 0 3/4	18"	2	10 15/16
34	33 0 1/2	37 1 7/8	20"	3	2 7/8
35	34 0 3/16	38 3	24"	3	10 5/8
36	34 11 13/16	39 4 1/8			
37	35 11 1/2	40 5 1/4			
38	36 11 1/8	41 6 5/16	PLUMB & SEAT CUTS FOR		
39	37 10 13/16	42 7 7/16	COMMON RAFTERS		
40	38 10 1/2	43 8 9/16	PLUMB	SEAT	
41	39 10 1/8	44 9 11/16	20	12	
42	40 9 13/16	45 10 13/16	HIP/VALLEY RAFTERS		
43	41 9 7/16	46 11 15/16	PLUMB	SEAT	
44	42 9 1/8	48 1	10	8 1/2	
45	43 8 13/16	49 2 1/8			
46	44 8 7/16	50 3 1/4			
47	45 8 1/8	51 4 3/8			
48	46 7 3/4	52 5 1/2			
49	47 7 7/16	53 6 5/8			
50	48 7 1/8	54 7 11/16			

RISE = 20.5 INCHES PER FOOT

BLDG WIDTH FEET	COMMON RAFTER FT INCHES	HIP/VALLEY RAFTER T INCHES	ADD'L WIDTH INCHES	ADD'L COMMON LENGTH	ADDED HIP/VAL LENGTH
1	0 11 7/8	1 1 1/4	0 1/2	0 1/2	0 9/16
2	1 11 3/4	2 2 9/16	1	0 15/16	1 1/8
3	2 11 5/8	3 3 7/8	1 1/2	1 1/2	1 11/16
4	3 11 1/2	4 5 3/16	2	1 15/16	2 3/16
5	4 11 3/8	5 6 1/2	2 1/2	2 1/2	2 3/4
6	5 11 1/4	6 7 13/16	3	2 15/16	3 5/16
7	6 11 1/8	7 9 1/8	3 1/2	3 7/16	3 7/8
8	7 11	8 10 7/16	4	3 15/16	4 7/16
9	8 10 7/8	9 11 3/4	4 1/2	4 7/16	4 15/16
10	9 10 3/4	11 1 1/16	5	4 15/16	5 9/16
11	10 10 5/8	12 2 5/16	5 1/2	5 7/16	6 1/8
12	11 10 1/2	13 3 5/8	6	5 15/16	6 5/8
13	12 10 3/8	14 5	6 1/2	6 7/16	7 3/16
14	13 10 1/4	15 6 1/4	7	6 15/16	7 3/4
15	14 10 1/8	16 7 9/16	7 1/2	7 7/16	8 5/16
16	15 10 1/16	17 8 7/8	8	7 15/16	8 7/8
17	16 9 15/16	18 10 3/16	8 1/2	8 7/16	9 7/16
18	17 9 13/16	19 11 1/2	9	8 15/16	9 15/16
19	18 9 11/16	21 0 13/16	9 1/2	9 3/8	10 9/16
20	19 9 9/16	22 2 1/8	10	9 7/8	11 1/16
21	20 9 7/16	23 3 3/8	10 1/2	10 3/8	11 5/8
22	21 9 5/16	24 4 11/16	11	10 7/8	12 3/16
23	22 9 3/16	25 6	11 1/2	11 3/8	12 3/4
24	23 9 1/16	26 7 5/16	12	11 7/8	13 5/16
25	24 8 15/16	27 8 5/8			
26	25 8 13/16	28 9 15/16			
27	26 8 11/16	29 11 1/4			
28	27 8 9/16	31 0 9/16			
29	28 8 7/16	32 1 7/8			
30	29 8 5/16	33 3 3/16			
31	30 8 3/16	34 4 1/2			
32	31 8 1/16	35 5 3/4			
33	32 7 15/16	36 7 1/16			
34	33 7 13/16	37 8 3/8			
35	34 7 11/16	38 9 11/16			
36	35 7 9/16	39 11			
37	36 7 7/16	41 0 5/16			
38	37 7 5/16	42 1 5/8			
39	38 7 3/16	43 2 15/16			
40	39 7 1/16	44 4 1/4			
41	40 6 15/16	45 5 9/16			
42	41 6 13/16	46 6 13/16			
43	42 6 11/16	47 8 1/8			
44	43 6 9/16	48 9 7/16			
45	44 6 7/16	49 10 3/4			
46	45 6 5/16	51 0 1/16			
47	46 6 3/16	52 1 3/8			
48	47 6 1/8	53 2 11/16			
49	48 6	54 4			
50	49 5 7/8	55 5 5/16			

DIFFERENCE IN JACK RAFTER LENGTHS FOR RAFTER SPACINGS		
ON CENTER	LENGTH DIFFERENCE	
	FEET	INCHES
12"	1	11 3/4
16"	2	7 11/16
18"	2	11 5/8
20"	3	3 9/16
24"	3	11 1/2

PLUMB & SEAT CUTS FOR	
COMMON RAFTERS	
PLUMB	SEAT
20 1/2	12
HIP/VALLEY RAFTERS	
PLUMB	SEAT
10 1/4	8 1/2

RISE = 21 INCHES PER FOOT

BLOG WIDTH FEET	COMMON RAFTER FT INCHES	HIP/VALLEY RAFTER FT INCHES	ADD'L WIDTH INCHES	ADD'L COMMON LENGTH	ADDED HIP/VAL LENGTH
1	1 0 1/16	1 1 1/2	0 1/2	0 1/2	0 9/16
2	2 0 3/16	2 3	1	1	1 1/8
3	3 0 1/4	3 4 1/2	1 1/2	1 1/2	1 11/16
4	4 0 3/8	4 6	2	2	2 1/4
5	5 0 7/16	5 7 1/2	2 1/2	2 1/2	2 13/16
6	6 0 9/16	6 9	3	3	3 3/8
7	7 0 5/8	7 10 1/2	3 1/2	3 1/2	3 15/16
8	8 0 3/4	8 0	4	4	4 1/2
9	9 0 13/16	10 1 1/2	4 1/2	4 9/16	5 1/16
10	10 0 15/16	11 3	5	5 1/16	5 5/8
11	11 1	12 4 1/2	5 1/2	5 9/16	6 3/16
12	12 1 1/8	13 6	6	6 1/16	6 3/4
13	13 1 3/16	14 7 1/2	6 1/2	6 9/16	7 5/16
14	14 1 5/16	15 9	7	7 1/16	7 7/8
15	15 1 3/8	16 10 1/2	7 1/2	7 9/16	8 7/16
16	16 1 1/2	18 0	8	8 1/16	9
17	17 1 9/16	19 1 1/2	8 1/2	8 9/16	9 9/16
18	18 1 11/16	20 3	9	9 1/16	10 1/8
19	19 1 3/4	21 4 1/2	9 1/2	9 9/16	10 11/16
20	20 1 7/8	22 6	10	10 1/16	11 1/4
21	21 1 15/16	23 7 1/2	10 1/2	10 9/16	11 13/16
22	22 2 1/16	24 9	11	11 1/16	12 3/8
23	23 2 1/8	25 10 1/2	11 1/2	11 9/16	12 15/16
24	24 2 1/4	27 0	12	12 1/16	13 1/2
25	25 2 5/16	28 1 1/2			
26	26 2 7/16	29 3			
27	27 2 1/2	30 4 1/2			
28	28 2 5/8	31 6			
29	29 2 11/16	32 7 1/2			
30	30 2 13/16	33 9			
31	31 2 7/8	34 10 1/2			
32	32 3	36 0			
33	33 3 1/16	37 1 1/2			
34	34 3 3/16	38 3			
35	35 3 1/4	39 4 1/2			
36	36 3 3/8	40 6			
37	37 3 7/16	41 7 1/2			
38	38 3 9/16	42 9			
39	39 3 5/8	43 10 1/2			
40	40 3 3/4	45 0			
41	41 3 13/16	46 1 1/2			
42	42 3 15/16	47 3			
43	43 4	48 4 1/2			
44	44 4 1/8	49 6			
45	45 4 3/16	50 7 1/2			
46	46 4 5/16	51 9			
47	47 4 3/8	52 10 1/2			
48	48 4 1/2	54 0			
49	49 4 9/16	55 1 1/2			
50	50 4 11/16	56 3			

DIFFERENCE IN JACK RAFTER LENGTHS FOR RAFTER SPACINGS		
ON CENTER	LENGTH DIFFERENCE	
	FEET	INCHES
12"	2	0 3/16
16"	2	8 1/4
18"	3	0 1/4
20"	3	4 5/16
24"	4	0 3/8

PLUMB & SEAT CUTS FOR	
COMMON RAFTERS	
PLUMB 21	SEAT 12
HIP/VALLEY RAFTERS	
PLUMB 10 1/2	SEAT 8 1/2

RISE = 21.5 INCHES PER FOOT

BLDG WIDTH FEET	COMMON RAFTER FT INCHES	HIP/VALLEY RAFTER FT INCHES	ADD'L WIDTH INCHES	ADD'L COMMON LENGTH	ADDED HIP/VAL LENGTH
1	1 0 5/16	1 1 11/16	0 1/2	0 1/2	0 9/16
2	2 0 5/8	2 3 3/8	1	1	1 1/8
3	3 0 15/16	3 5 1/16	1 1/2	1 9/16	1 11/16
4	4 1 1/4	4 6 3/4	2	2 1/16	2 5/16
5	5 1 9/16	5 8 7/16	2 1/2	2 9/16	2 7/8
6	6 1 7/8	6 10 1/8	3	3 1/16	3 7/16
7	7 2 3/16	7 11 13/16	3 1/2	3 9/16	3 15/16
8	8 2 1/2	9 1 9/16	4	4 1/8	4 9/16
9	9 2 13/16	10 3 1/4	4 1/2	4 5/8	5 1/8
10	10 3 1/8	11 4 15/16	5	5 1/8	5 11/16
11	11 3 7/16	12 6 5/8	5 1/2	5 5/8	6 1/4
12	12 3 3/4	13 8 5/16	6	6 1/8	6 7/8
13	13 4 1/16	14 10	6 1/2	6 11/16	7 7/16
14	14 4 3/8	15 11 11/16	7	7 3/16	7 15/16
15	15 4 11/16	17 1 3/8	7 1/2	7 11/16	8 9/16
16	16 5	18 3 1/8	8	8 3/16	9 1/8
17	17 5 5/16	19 4 13/16	8 1/2	8 3/4	9 11/16
18	18 5 5/8	20 6 1/2	9	9 1/4	10 1/4
19	19 5 15/16	21 8 3/16	9 1/2	9 3/4	10 13/16
20	20 6 1/4	22 9 7/8	10	10 1/4	11 7/16
21	21 6 9/16	23 11 9/16	10 1/2	10 3/4	11 15/16
22	22 6 13/16	25 1 1/4	11	11 5/16	12 9/16
23	23 7 1/8	26 3	11 1/2	11 13/16	13 1/8
24	24 7 7/16	27 4 11/16	12	12 5/16	13 11/16
25	25 7 3/4	28 6 3/8	DIFFERENCE IN JACK RAFTER LENGTHS FOR RAFTER SPACINGS		
26	26 8 1/16	29 8 1/16	ON CENTER		
27	27 8 3/8	30 9 3/4			
28	28 8 11/16	31 11 7/16	LENGTH DIFFERENCE		
29	29 9	33 1 1/8	FEET		INCHES
30	30 9 5/16	34 2 13/16	12"	2	0 5/8
31	31 9 5/8	35 4 1/2	16"	2	8 13/16
32	32 9 15/16	36 6 1/4	18"	3	0 15/16
33	33 10 1/4	37 7 15/16	20"	3	5 1/16
34	34 10 9/16	38 9 5/8	24"	4	1 1/4
35	35 10 7/8	39 11 5/16	PLUMB & SEAT CUTS FOR		
36	36 11 3/16	41 1	COMMON RAFTERS		
37	37 11 1/2	42 2 11/16	PLUMB	SEAT	
38	38 11 13/16	43 4 3/8	21 1/2	12	
39	40 0 1/8	44 6 1/16	HIP/VALLEY RAFTERS		
40	41 0 7/16	45 7 13/16	PLUMB	SEAT	
41	42 0 3/4	46 9 1/2	10 3/4	8 1/2	
42	43 1 1/16	47 11 3/16			
43	44 1 3/8	49 0 7/8			
44	45 1 11/16	50 2 9/16			
45	46 2	51 4 1/4			
46	47 2 5/16	52 6			
47	48 2 5/8	53 7 5/8			
48	49 2 15/16	54 9 3/8			
49	50 3 1/4	55 11 1/16			
50	51 3 9/16	57 0 3/4			

RISE = 22 INCHES PER FOOT

BLDG WIDTH FEET	COMMON RAFTER FT INCHES	HIP/VALLEY RAFTER FT INCHES	ADD'L WIDTH INCHES	ADD L COMMON LENGTH	ADDED HIP/VAL LENGTH
1	1 0 1/2	1 1 7/8	0 1/2	0 1/2	0 9/16
2	2 1 1/16	2 3 3/4	1	1 1/16	1 3/16
3	3 1 9/16	3 5 5/8	1 1/2	1 9/16	1 3/4
4	4 2 1/8	4 7 9/16	2	2 1/16	2 5/16
5	5 2 5/8	5 9 7/16	2 1/2	2 5/8	2 7/8
6	6 3 3/16	6 11 5/16	3	3 1/8	3 1/2
7	7 3 11/16	8 1 3/16	3 1/2	3 5/8	4 1/16
8	8 4 1/4	9 3 1/8	4	4 3/16	4 5/8
9	9 4 3/4	10 5	4 1/2	4 11/16	5 3/16
10	10 5 5/16	11 6 7/8	5	5 1/4	5 13/16
11	11 5 13/16	12 8 13/16	5 1/2	5 3/4	6 3/8
12	12 6 3/8	13 10 11/16	6	6 1/4	6 15/16
13	13 6 7/8	15 0 9/16	6 1/2	6 13/16	7 1/2
14	14 7 7/16	16 2 7/16	7	7 5/16	8 1/8
15	15 7 15/16	17 4 3/8	7 1/2	7 13/16	8 11/16
16	16 8 1/2	18 6 1/4	8	8 3/8	9 1/4
17	17 9	19 8 1/8	8 1/2	8 7/8	9 13/16
18	18 9 9/16	20 10 1/16	9	9 3/8	10 7/16
19	19 10 1/16	21 11 15/16	9 1/2	9 15/16	10 15/16
20	20 10 5/8	23 1 13/16	10	10 7/16	11 9/16
21	21 11 1/8	24 3 11/16	10 1/2	10 15/16	12 1/8
22	22 11 11/16	25 5 5/8	11	11 1/2	12 3/4
23	24 0 3/16	26 7 1/2	11 1/2	12	13 5/16
24	25 0 3/4	27 9 3/8	12	12 1/2	13 7/8
25	26 1 1/4	28 11 1/4			
26	27 1 3/4	30 1 3/16			
27	28 2 5/16	31 3 1/16			
28	29 2 13/16	32 5			
29	30 3 3/8	33 6 7/8			
30	31 3 7/8	34 8 3/4			
31	32 4 7/16	35 10 5/8			
32	33 4 15/16	37 0 1/2			
33	34 5 1/2	38 2 7/16			
34	35 6	39 4 5/16			
35	36 6 9/16	40 6 3/16			
36	37 7 1/16	41 8 1/8			
37	38 7 5/8	42 10			
38	39 8 1/8	43 11 7/8			
39	40 8 11/16	45 1 3/4			
40	41 9 3/16	46 3 11/16			
41	42 9 3/4	47 5 9/16			
42	43 10 1/4	48 7 7/16			
43	44 10 13/16	49 9 3/8			
44	45 11 5/16	50 11 1/4			
45	46 11 7/8	52 1 1/8			
46	48 0 3/8	53 3			
47	49 0 15/16	54 4 15/16			
48	50 1 7/16	55 6 13/16			
49	51 1 15/16	56 8 11/16			
50	52 2 1/2	57 10 9/16			

DIFFERENCE IN JACK RAFTER LENGTHS FOR RAFTER SPACINGS		
ON CENTER	LENGTH DIFFERENCE	
	FEET	INCHES
12"	2	1 1/16
16"	2	9 7/16
18"	3	1 9/16
20"	3	5 3/4
24"	4	2 1/8

PLUMB & SEAT CUTS FOR	
COMMON RAFTERS	
PLUMB 22	SEAT 12
HIP/VALLEY RAFTERS	
PLUMB 11	SEAT 8 1/2

RISE = 22.5 INCHES PER FOOT

BLDG WIDTH FEET	COMMON RAFTER FT INCHES	HIP/VALLEY RAFTER FT INCHES	ADD'L WIDTH INCHES	ADD'L COMMON LENGTH	ADDED HIP/VAL LENGTH
1	1 0 3/4	1 2 1/16	0 1/2	0 9/16	0 9/16
2	2 1 1/2	2 4 1/8	1	1 1/16	1 3/16
3	3 2 1/4	3 6 1/4	1 1/2	1 5/8	1 3/4
4	4 3	4 8 5/16	2	2 1/8	2 3/8
5	5 3 3/4	5 10 7/16	2 1/2	2 11/16	2 15/16
6	6 4 1/2	7 0 1/2	3	3 3/16	3 1/2
7	7 5 1/4	8 2 5/8	3 1/2	3 3/4	4 1/8
8	8 6	9 4 11/16	4	4 1/4	4 11/16
9	9 6 3/4	10 6 13/16	4 1/2	4 13/16	5 5/16
10	10 7 1/2	11 8 7/8	5	5 5/16	5 7/8
11	11 8 1/4	12 11	5 1/2	5 7/8	6 7/16
12	12 9	14 1 1/16	6	6 3/8	7 1/16
13	13 9 3/4	15 3 1/8	6 1/2	6 15/16	7 5/8
14	14 10 1/2	16 5 1/4	7	7 7/16	8 1/4
15	15 11 1/4	17 7 5/16	7 1/2	7 15/16	8 13/16
16	17 0	18 9 7/16	8	8 1/2	9 3/8
17	18 0 3/4	19 11 1/2	8 1/2	9 1/16	9 15/16
18	19 1 1/2	21 1 5/8	9	9 9/16	10 9/16
19	20 2 1/4	22 3 11/16	9 1/2	10 1/8	11 1/8
20	21 3	23 5 13/16	10	10 5/8	11 3/4
21	22 3 3/4	24 7 7/8	10 1/2	11 3/16	12 5/16
22	23 4 1/2	25 10	11	11 11/16	12 15/16
23	24 5 1/4	27 0 1/16	11 1/2	12 1/4	13 1/2
24	25 6	28 2 3/16	12	12 3/4	14 1/16
25	26 6 3/4	29 4 1/4			
26	27 7 1/2	30 6 5/16			
27	28 8 1/4	31 8 7/16			
28	29 9	32 10 1/2			
29	30 9 3/4	34 0 5/8			
30	31 10 1/2	35 2 11/16			
31	32 11 1/4	36 4 13/16			
32	34 0	37 6 7/8			
33	35 0 3/4	38 9			
34	36 1 1/2	39 11 1/16			
35	37 2 1/4	41 1 3/16			
36	38 3	42 3 1/4			
37	39 3 3/4	43 5 3/8			
38	40 4 1/2	44 7 7/16			
39	41 5 1/4	45 9 1/2			
40	42 6	46 11 5/8			
41	43 6 3/4	48 1 11/16			
42	44 7 1/2	49 3 13/16			
43	45 8 1/4	50 5 7/8			
44	46 9	51 8			
45	47 9 3/4	52 10 1/16			
46	48 10 1/2	54 0 3/16			
47	49 11 1/4	55 2 1/4			
48	51 0	56 4 3/8			
49	52 0 3/4	57 6 7/16			
50	53 1 1/2	58 8 1/2			

DIFFERENCE IN JACK RAFTER LENGTHS FOR RAFTER SPACINGS		
ON CENTER	LENGTH DIFFERENCE	
	FEET	INCHES
12"	2	1 1/2
16"	2	10
18"	3	2 1/4
20"	3	6 1/2
24"	4	3

PLUMB & SEAT CUTS FOR	
COMMON RAFTERS	
PLUMB	SEAT
22 1/2	12
HIP/VALLEY RAFTERS	
PLUMB	SEAT
11 1/4	8 1/2

RISE = 23 INCHES PER FOOT

BLDG WIDTH FEET	COMMON RAFTER FT INCHES	HIP/VALLEY RAFTER FT INCHES	ADD'L WIDTH INCHES	ADD'L COMMON LENGTH	ADDED HIP/VAL LENGTH
1	1 1	1 2 1/4	0 1/2	0 9/16	0 5/8
2	2 1 15/16	2 4 9/16	1	1 1/16	1 3/16
3	3 2 15/16	3 6 13/16	1 1/2	1 5/8	1 13/16
4	4 3 7/8	4 9 1/8	2	2 3/16	2 3/8
5	5 4 7/8	5 11 7/16	2 1/2	2 11/16	2 15/16
6	6 5 13/16	7 1 11/16	3	3 1/4	3 9/16
7	7 6 13/16	8 4	3 1/2	3 13/16	4 3/16
8	8 7 3/4	9 6 5/16	4	4 5/16	4 3/4
9	9 8 3/4	10 8 9/16	4 1/2	4 7/8	5 3/8
10	10 9 11/16	11 10 7/8	5	5 3/8	5 15/16
11	11 10 11/16	13 1 3/16	5 1/2	5 15/16	6 9/16
12	12 11 5/8	14 3 7/16	6	6 1/2	7 1/8
13	14 0 5/8	15 5 3/4	6 1/2	7	7 3/4
14	15 1 5/8	16 8 1/16	7	7 9/16	8 5/16
15	16 2 9/16	17 10 5/16	7 1/2	8 1/8	8 15/16
16	17 3 9/16	19 0 5/8	8	8 5/8	9 1/2
17	18 4 1/2	20 2 15/16	8 1/2	9 3/16	10 1/8
18	19 5 1/2	21 5 3/16	9	9 3/4	10 11/16
19	20 6 7/16	22 7 1/2	9 1/2	10 1/4	11 5/16
20	21 7 7/16	23 9 13/16	10	10 13/16	11 15/16
21	22 8 3/8	25 0 1/16	10 1/2	11 3/8	12 1/2
22	23 9 3/8	26 2 3/8	11	11 7/8	13 1/8
23	24 10 5/16	27 4 11/16	11 1/2	12 7/16	13 11/16
24	25 11 5/16	28 7	12	12 15/16	14 5/16
25	27 0 1/4	29 9 1/4	DIFFERENCE IN JACK RAFTER LENGTHS FOR RAFTER SPACINGS		
26	28 1 1/4	30 11 9/16	ON CENTER LENGTH DIFFERENCE		
27	29 2 1/4	32 1 13/16			
28	30 3 3/16	33 4 1/8	FEET INCHES		
29	31 4 3/16	34 6 7/16			
30	32 5 1/8	35 8 11/16			
31	33 6 1/8	36 11			
32	34 7 1/16	38 1 5/16			
33	35 8 1/16	39 3 9/16	12"	2	1 15/16
34	36 9	40 5 7/8	16"	2	10 9/16
35	37 10	41 8 3/16	18"	3	2 15/16
36	38 10 15/16	42 10 7/16	20"	3	7 1/4
37	39 11 15/16	44 0 3/4	24"	4	3 7/8
38	41 0 7/8	45 3 1/16	PLUMB & SEAT CUTS FOR		
39	42 1 7/8	46 5 5/16	COMMON RAFTERS		
40	43 2 7/8	47 7 5/8	PLUMB SEAT		
41	44 3 13/16	48 9 15/16	23 12		
42	45 4 13/16	50 0 3/16	HIP/VALLEY RAFTERS		
43	46 5 3/4	51 2 1/2	PLUMB SEAT		
44	47 6 3/4	52 4 13/16	11 1/2 8 1/2		
45	48 7 11/16	53 7 1/16			
46	49 8 11/16	54 9 3/8			
47	50 9 5/8	55 11 11/16			
48	51 10 5/8	57 2			
49	52 11 9/16	58 4 1/4			
50	54 0 9/16	59 6 9/16			

RISE = 23.5 INCHES PER FOOT

BLDG WIDTH FEET	COMMON RAFTER FT INCHES	HIP/VALLEY RAFTER FT INCHES	ADD'L WIDTH INCHES	ADD'L COMMON LENGTH	ADDED HIP/VAL LENGTH
1	1 1 3/16	1 2 7/16	0 1/2	0 9/16	0 5/8
2	2 2 3/8	2 5	1	1 1/8	1 3/16
3	3 3 9/16	3 7 7/16	1 1/2	1 5/8	1 13/16
4	4 4 3/4	4 10	2	2 3/16	2 7/16
5	5 5 15/16	6 0 7/16	2 1/2	2 3/4	3
6	6 7 3/16	7 2 15/16	3	3 5/16	3 5/8
7	7 8 3/8	8 5 7/16	3 1/2	3 7/8	4 1/4
8	8 9 9/16	9 7 15/16	4	4 3/8	4 13/16
9	9 10 3/4	10 10 7/16	4 1/2	4 15/16	5 7/16
10	10 11 15/16	12 0 7/8	5	5 1/2	6 1/16
11	12 1 1/8	13 3 3/8	5 1/2	6 1/16	6 5/8
12	13 2 5/16	14 5 7/8	6	6 5/8	7 1/4
13	14 3 1/2	15 8 3/8	6 1/2	7 1/8	7 7/8
14	15 4 11/16	16 10 7/8	7	7 11/16	8 7/16
15	16 5 7/8	18 1 3/8	7 1/2	8 1/4	9 1/16
16	17 7 1/16	19 3 7/8	8	8 13/16	9 11/16
17	18 8 5/16	20 6 3/8	8 1/2	9 3/8	10 1/4
18	19 9 1/2	21 8 7/8	9	9 7/8	10 7/8
19	20 10 11/16	22 11 3/8	9 1/2	10 7/16	11 1/2
20	21 11 7/8	24 1 13/16	10	10 15/16	12 1/16
21	23 1 1/16	25 4 5/16	10 1/2	11 9/16	12 11/16
22	24 2 1/4	26 6 13/16	11	12 1/8	13 5/16
23	25 3 7/16	27 9 5/16	11 1/2	12 5/8	13 7/8
24	26 4 5/8	28 11 13/16	12	13 3/16	14 1/2
25	27 5 13/16	30 2 5/16			
26	28 7	31 4 13/16			
27	29 8 3/16	32 7 5/16			
28	30 9 7/16	33 9 13/16			
29	31 10 5/8	35 0 1/4			
30	32 11 13/16	36 2 3/4			
31	34 1	37 5 1/4			
32	35 2 3/16	38 7 3/4			
33	36 3 3/8	39 10 1/4			
34	37 4 9/16	41 0 3/4			
35	38 5 3/4	42 3 1/4			
36	39 6 15/16	43 5 3/4			
37	40 8 1/8	44 8 1/4			
38	41 9 3/8	45 10 3/4			
39	42 10 9/16	47 1 3/16			
40	43 11 3/4	48 3 11/16			
41	45 0 15/16	49 6 3/16			
42	46 2 1/8	50 8 11/16			
43	47 3 5/16	51 11 3/16			
44	48 4 1/2	53 1 11/16			
45	49 5 11/16	54 4 3/16			
46	50 6 7/8	55 6 11/16			
47	51 8 1/16	56 9 3/16			
48	52 9 1/4	57 11 11/16			
49	53 10 1/2	59 2 1/8			
50	54 11 11/16	60 4 5/8			

DIFFERENCE IN JACK RAFTER LENGTHS FOR RAFTER SPACINGS		
ON CENTER	LENGTH DIFFERENCE	
	FEET	INCHES
12"	2	2 3/8
16"	2	11 3/16
18"	3	3 9/16
20"	3	7 15/16
24"	4	4 3/4

PLUMB & SEAT CUTS FOR	
COMMON RAFTERS	
PLUMB	SEAT
23 1/2	12
HIP/VALLEY RAFTERS	
PLUMB	SEAT
11 3/4	8 1/2

RISE = 24 INCHES PER FOOT

BLDG WIDTH FEET	COMMON RAFTER FT INCHES	HIP/VALLEY RAFTER FT INCHES	ADD'L WIDTH INCHES	ADD'L COMMON LENGTH	ADDED HIP/VAL LENGTH
1	1 1 7/16	1 2 11/16	0 1/2	0 9/16	0 5/8
2	2 2 13/16	2 5 3/8	1	1 1/8	1 1/4
3	3 4 1/4	3 8 1/16	1 1/2	1 11/16	1 13/16
4	4 5 11/16	4 10 3/4	2	2 1/4	2 7/16
5	5 7 1/16	6 1 7/16	2 1/2	2 13/16	3 1/16
6	6 8 1/2	7 4 1/8	3	3 3/8	3 11/16
7	7 9 15/16	8 6 7/8	3 1/2	3 15/16	4 5/16
8	8 11 5/16	9 9 9/16	4	4 1/2	4 7/8
9	10 0 3/4	11 0 1/4	4 1/2	5	5 1/2
10	11 2 3/16	12 3	5	5 9/16	6 1/8
11	12 3 9/16	13 5 5/8	5 1/2	6 1/8	6 3/4
12	13 5	14 8 5/16	6	6 11/16	7 3/8
13	14 6 7/16	15 11	6 1/2	7 1/4	7 15/16
14	15 7 13/16	17 1 3/4	7	7 13/16	8 9/16
15	16 9 1/4	18 4 7/16	7 1/2	8 3/8	9 3/16
16	17 10 11/16	19 7 1/8	8	8 15/16	9 13/16
17	19 0 1/16	20 9 13/16	8 1/2	9 1/2	10 7/16
18	20 1 1/2	22 0 1/2	9	10 1/16	11
19	21 2 15/16	23 3 3/16	9 1/2	10 5/8	11 5/8
20	22 4 5/16	24 5 15/16	10	11 3/16	12 1/4
21	23 5 3/4	25 8 5/8	10 1/2	11 3/4	12 7/8
22	24 7 3/16	26 11 5/16	11	12 5/16	13 1/2
23	25 8 9/16	28 2	11 1/2	12 7/8	14 1/16
24	26 10	29 4 11/16	12	13 7/16	14 11/16
25	27 11 7/16	30 7 3/8			
26	29 0 13/16	31 10 1/16			
27	30 2 1/4	33 0 13/16			
28	31 3 11/16	34 3 1/2			
29	32 5 1/16	35 6 3/16			
30	33 6 1/2	36 8 7/8			
31	34 7 15/16	37 11 9/16			
32	35 9 5/16	39 2 1/4			
33	36 10 3/4	40 5			
34	38 0 3/16	41 7 11/16			
35	39 1 9/16	42 10 3/8			
36	40 3	44 1 1/16			
37	41 4 7/16	45 3 3/4			
38	42 5 13/16	46 6 7/16			
39	43 7 1/4	47 9 1/8			
40	44 8 11/16	48 11 7/8			
41	45 10 1/16	50 2 9/16			
42	46 11 1/2	51 5 1/4			
43	48 0 7/8	52 7 15/16			
44	49 2 5/16	53 10 5/8			
45	50 3 3/4	55 1 5/16			
46	51 5 1/8	56 4			
47	52 6 9/16	57 6 3/4			
48	53 8	58 9 7/16			
49	54 9 3/8	60 0 1/8			
50	55 10 13/16	61 2 13/16			

DIFFERENCE IN JACK RAFTER LENGTHS FOR RAFTER SPACINGS		
	ON CENTER	LENGTH DIFFERENCE
		FEET INCHES
	12"	2 2 13/16
	16"	2 11 3/4
	18"	3 4 1/4
	20"	3 8 3/4
	24"	4 5 11/16

PLUMB & SEAT CUTS FOR	
COMMON RAFTERS	
PLUMB 24	SEAT 12
HIP/VALLEY RAFTERS	
PLUMB 12	SEAT 8 1/2



NOTES



STANLEY®

STEEL SQUARES

CHOICE OF THE PROFESSIONAL

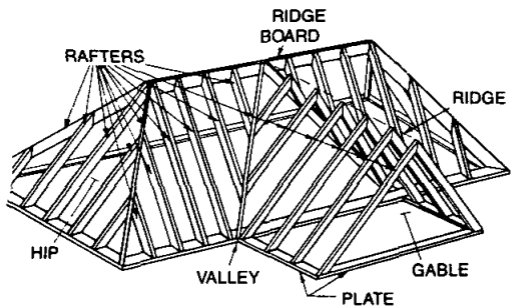

WORK SAFELY WITH TOOLS BY WEARING SAFETY GOGGLES



MADE IN U.S.A.

• STANLEY TOOLS/DIV OF THE STANLEY WORKS
New Britain, CT 06050 U.S.A.