

STANLEY

HOW TO WHET

STANLEY PLANE IRONS

(THIS ALSO APPLIES TO CHISELS)

STANLEY

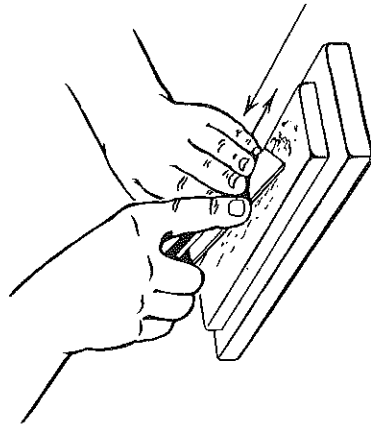

Whet the Plane Iron on the oil stone to produce the real sharp cutting edge. Hold the Plane Iron in the right hand with the left hand helping. Place the bevel on the stone with the back edge slightly raised. Move the Plane Iron Back and Forth.

TO KEEP THE BEVEL STRAIGHT

Be sure the hands move parallel to the stone so that the angle between the Plane Iron and the stone will stay the same throughout the stroke.

Use enough oil to keep the surface of the stone moist. It keeps the stone sharp by preventing particles of steel filling the pores of the stone. Try to wear the stone evenly.

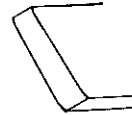

Plane marks will show less on a finished surface if the corners of the Plane Iron are slightly rounded.

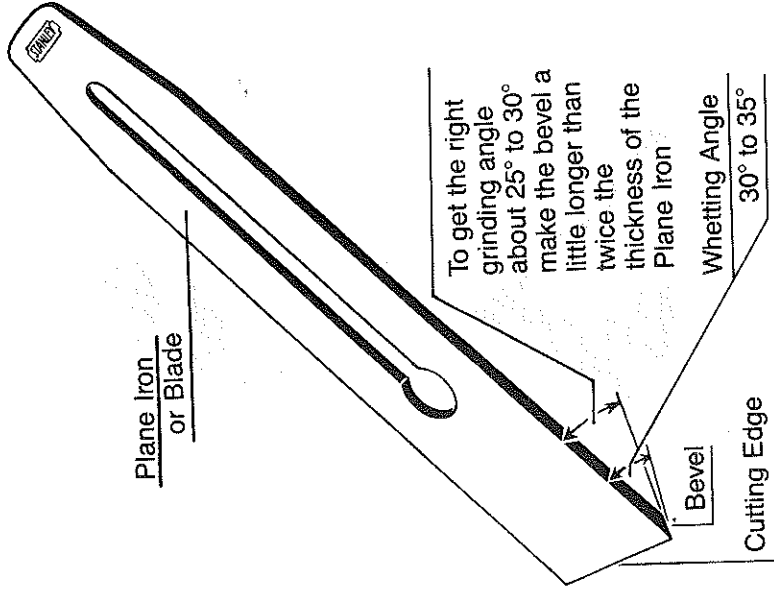

Plane Iron
or Blade

To get the right grinding angle about 25° to 30° make the bevel a little longer than twice the thickness of the Plane Iron

Whetting Angle
30° to 35°

Bevel

Cutting Edge

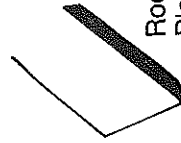

Rocking the Plane Iron produces a round bevel that will not cut well.

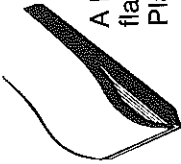

A bevel on the flat side of the Plane Iron prevents the Cap Iron fitting tight, shavings will clog the plane.

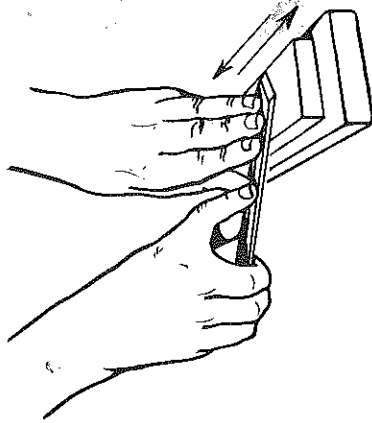

Remove the wire or feather edge by taking a few strokes with the flat side of the Plane Iron held FLAT on the stone. Avoid the slightest bevel on this side. If a nick or a shiny edge of bluntness can be seen, repeat both processes of whetting.

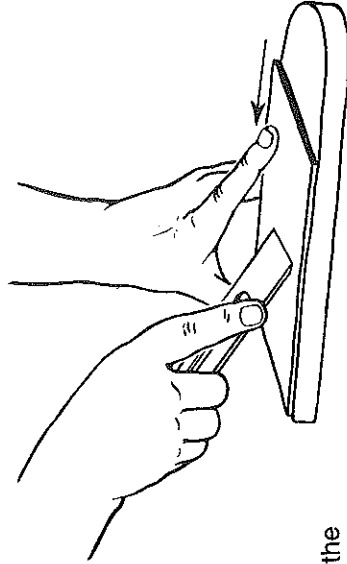

Finish with a few strokes on a leather strap to produce a keener edge.

EDUCATIONAL DEPARTMENT
CHART NO. 15
BY R.O. REGER

PRINTED IN U.S.A.

WORK SAFELY WITH TOOLS BY WEARING SAFETY GOGGLES

