

STANLEY® Jr.

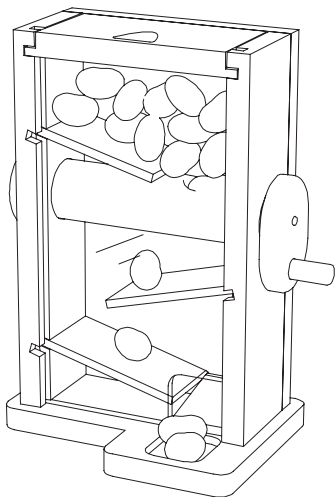

5+

Candy Maze Kit

ASSEMBLY INSTRUCTIONS

STANLEY[®] Jr.

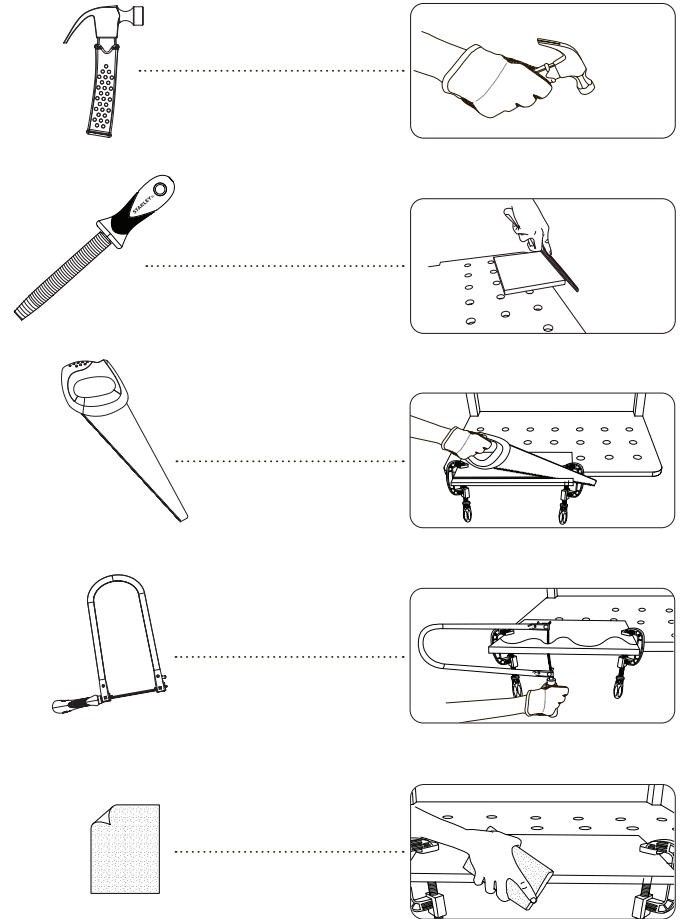

Parental guidance and direct supervision required at all times.

ASSEMBLY INSTRUCTIONS

30min

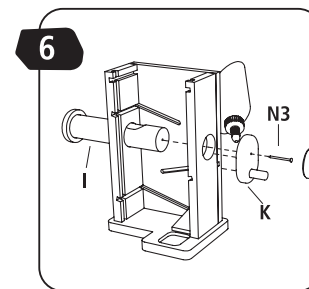
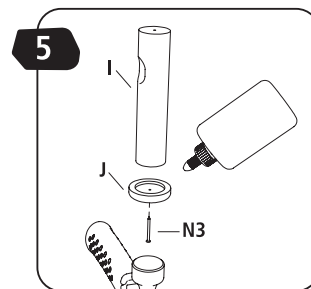
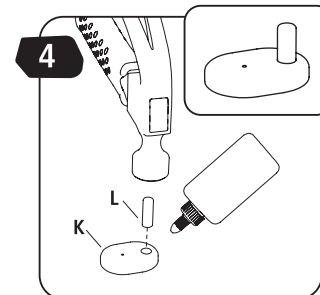
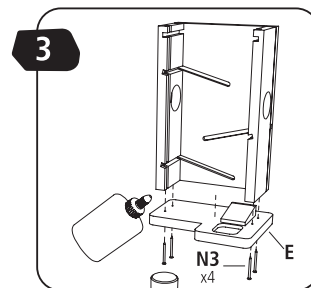
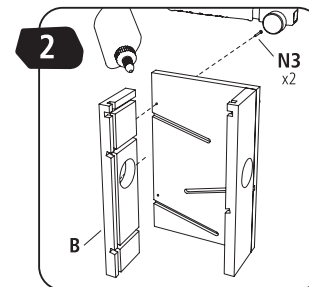
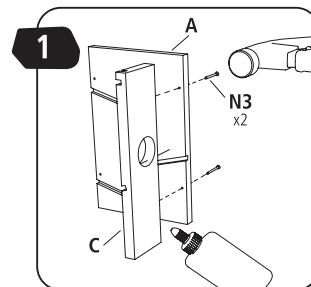
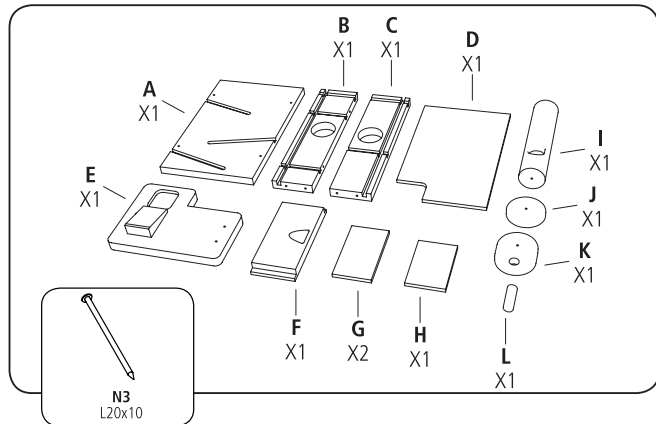
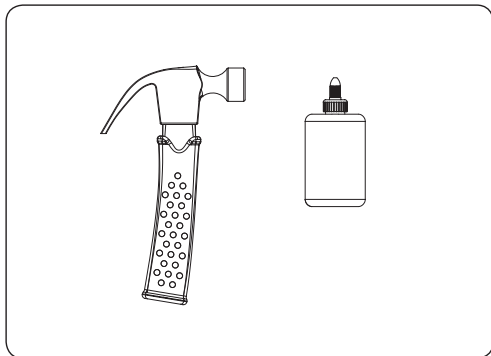

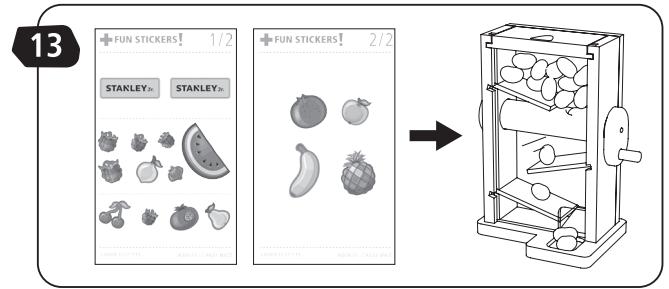
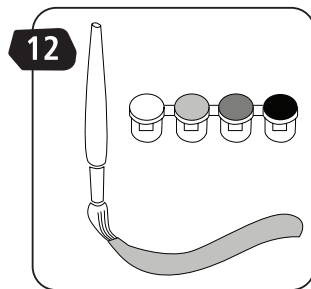
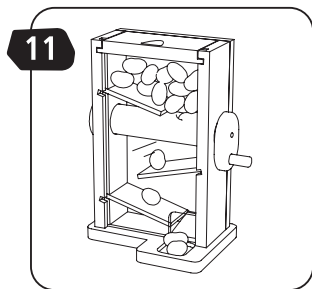
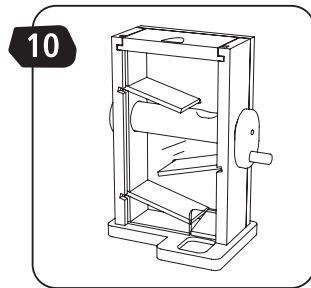
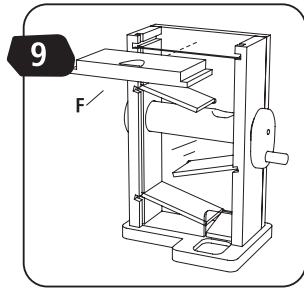
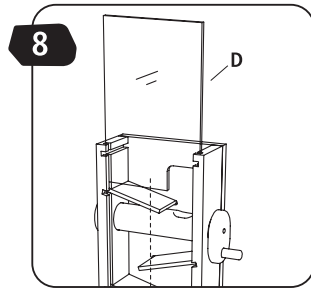
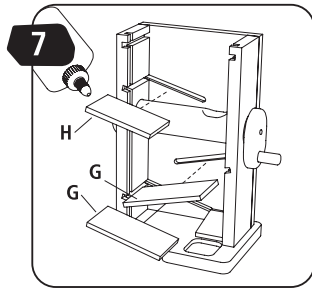

STANLEY® Jr.

©2016 Stanley Black & Decker, Inc.
The STANLEY Jr. and STANLEY Jr. logo are trademarks of
Stanley Black & Decker, Inc. or an affiliate thereof and are
used under license.

Products are manufactured by:

Red Tool Box Ltd.
4th Floor, #1 Building
655-77 Qiming Road
Investment & Business
Incubation Center, Yinzhou, Ningbo
315055, Zhejiang, China



WARNING: CHOKING HAZARD—Small parts.
Not for children under 3 years.



CAUTION: FUNCTIONAL SHARP POINTS AND EDGES.
Use with care. Adult Supervision Recommended.

CE