

# STANLEY® Jr.

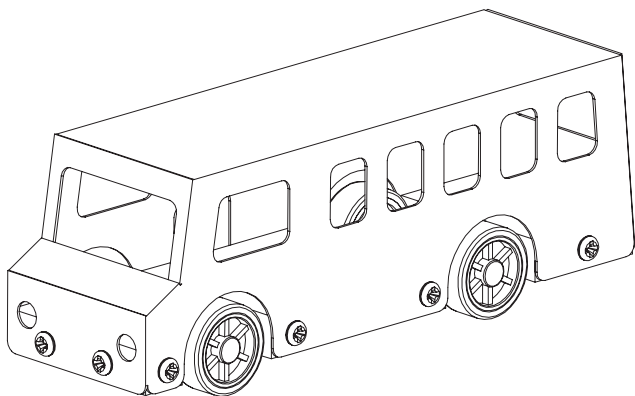

**5+**

**School Bus Kit**

ASSEMBLY INSTRUCTIONS

# STANLEY<sup>®</sup> Jr.

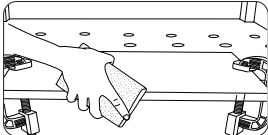
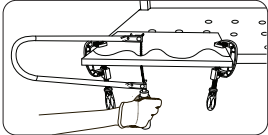
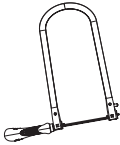
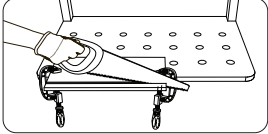
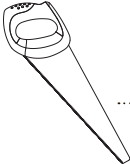
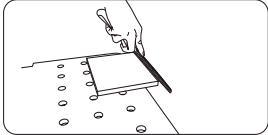
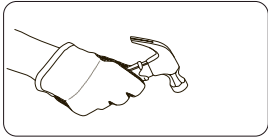
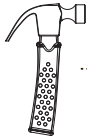
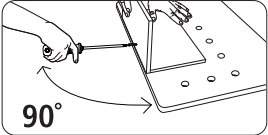
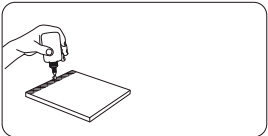
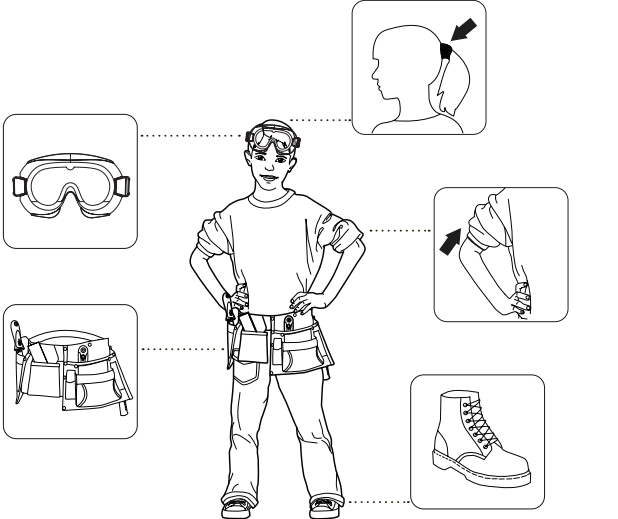

Parental guidance and direct supervision required at all times.

# ASSEMBLY INSTRUCTIONS

30min

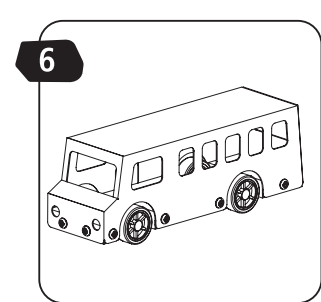
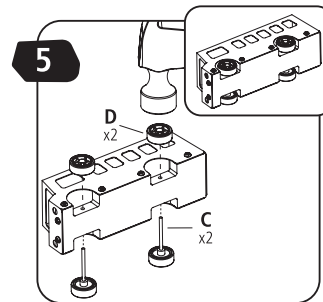
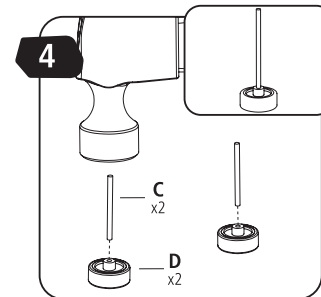
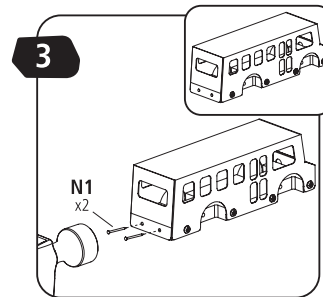
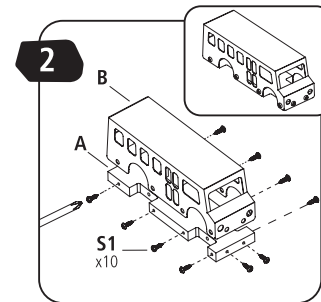
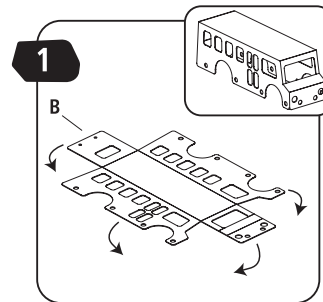
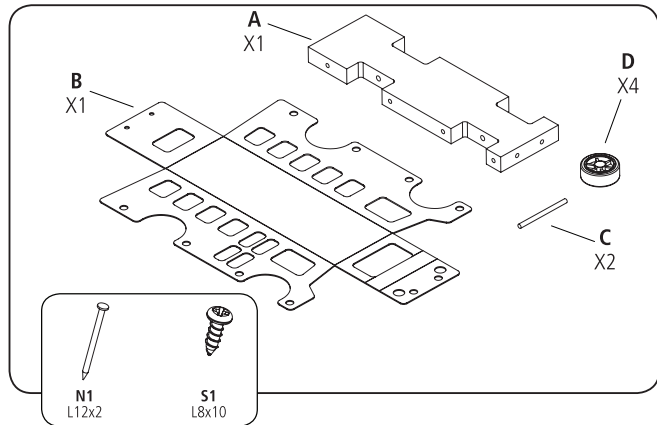
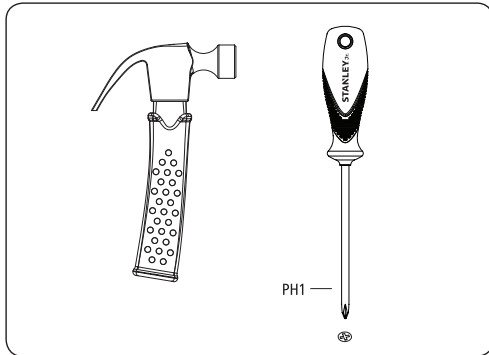

7

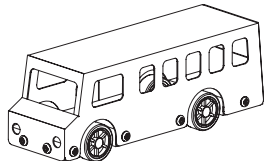
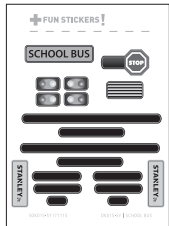

# STANLEY® Jr.

©2016 Stanley Black & Decker, Inc.  
The STANLEY Jr. and STANLEY Jr. logo are trademarks of  
Stanley Black & Decker, Inc. or an affiliate thereof and are  
used under license.

**Products are manufactured by:**

Red Tool Box Ltd.  
4th Floor, #1 Building  
655-77 Qiming Road  
Investment & Business  
Incubation Center, Yinzhou, Ningbo  
315055, Zhejiang, China



**WARNING: CHOKING HAZARD**—Small parts.  
Not for children under 3 years.



**CAUTION: FUNCTIONAL SHARP POINTS AND EDGES.**  
Use with care. Adult Supervision Recommended.

